

## On/Off Setpoint Control 226

The tekmar On/Off Setpoint Control type 226 is designed to maintain a constant temperature at its temperature sensor through the operation of a pump, boiler(s) or two-way valve.

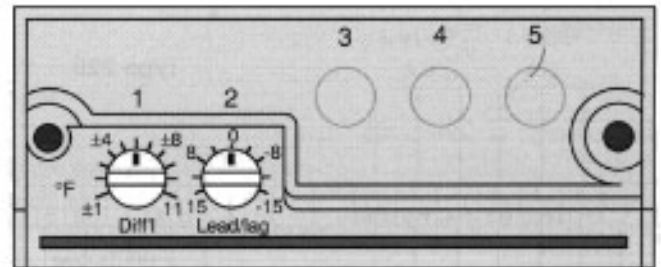
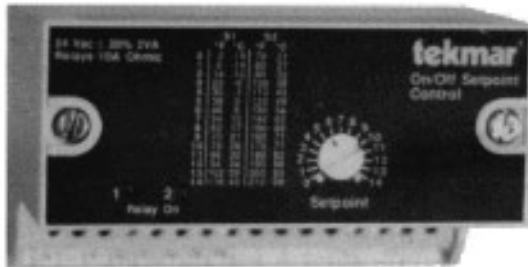

Type 226 has two SPDT relays. Relay 1 is set to switch at the setpoint or to lead or lag the setpoint by up to 15°F (8°C). Relay 2 switches at the setpoint. Once the sensor temperature rises above the setpoint, then relay 2 can either turn off immediately or after a 3 minute time delay. The setpoint is adjustable from -2°F (-20°C) to 210°F (100°C) in two ranges: low range is -2°F (-20°C) to 110°F (43°C), and high range is from 70°F (21°C) to 210°F (100°C). The differential of the control is adjustable from ±1°F (±0.5°C) to ±11°F (±6°C).

**Included with the 226:** 1. Electronic control, 2. Plug-in base, 3. General Purpose Sensor 318 and cable tie.

**For application examples see brochure A 226**

## Mixing Valve Setpoint Control 227

The tekmar Mixing Valve Setpoint Control type 227 is designed to maintain a constant temperature at its temperature sensor through the control of a mixing valve with an actuating motor that is operated by a floating 24Vac signal.

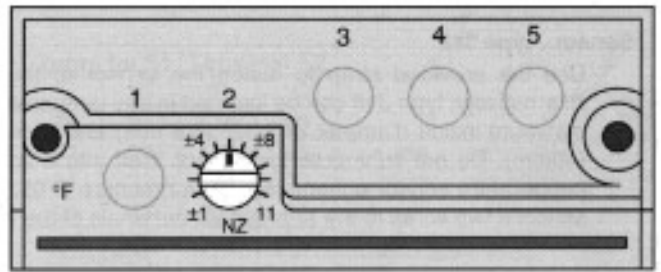
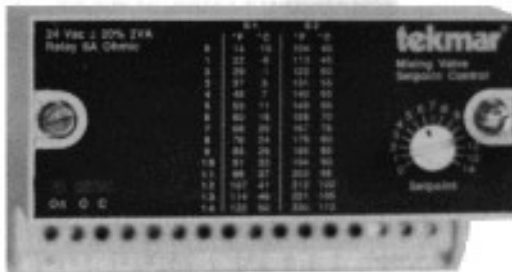

The Mixing Valve Setpoint Control type 227 operates a 24Vac floating Actuating Motor which in turn can adjust the setting of a mixing valve or damper. The control has two isolated SPST relays: one relay powers the actuating motor to open the valve, the second relay powers the actuating motor to close the valve. If the actual temperature is close to the setpoint then neither relay is on and the valve remains at its present setting. This neutral zone is adjustable from ±1°F (±0.5°C) to ±11°F (±6°C). The setpoint is adjustable from 14°F (-10°C) to 230°F (110°C) in two ranges: low range is 14°F (-10°C) to 122°F (50°C), and the high range is 104°F (40°C) to 230°F (110°C).

**Included with the 227:** 1. Electronic control, 2. Plug-in base, 3. General Purpose Sensor 318 and cable tie.

**For application examples see brochure A 227**

## Technical Data

Dimensions (h x w x d)	— 2-1/2 x 4-1/4 x 2-7/8" (64 x 108 x 73mm)
Weight	— 0.8 lbs (0.35 kg)
Ambient	— 30 - 120°F (0 - 50°C) < 95% RH non-condensing
Power Supply	— 24Vac ±10%, 60 Hz, 3 VA Class 2 Transformer
Relay Capacity	— 24Vac, 6 Amp
Temperature Sensor	— NTC thermistor, 2kΩ at 77°F (25°C)

## Installation

### Mechanical

The control is removed from its base by loosening the two screws at either side of the control faceplate and pulling the control out of the base. The control's base can then be mounted on a rail system or attached to a flat surface.

### Electrical

The tekmar control terminates the wires in a plug-in base; no wires are directly connected to the control. This plug-in system simplifies installation and troubleshooting procedures. Terminals N & L of the base must be connected to the secondary side of a 24 Vac class 2 transformer. The total load of the control is approximately 3 VA.

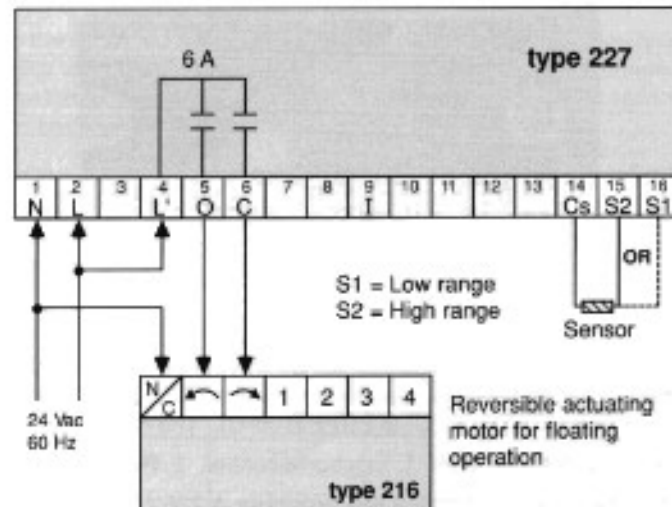
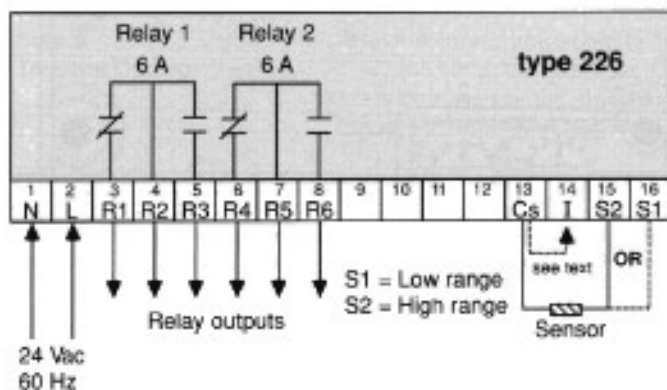

Note: Relays are shown in their normal, power off position.

### Installation of the Sensor

Note: The sensor is connected to the base using a 2-conductor cable (eg. 2 x 18 AWG). The overall length of the cable can be 1000 ft. (300 m) but the cable must not be run parallel to any power line or telephone cables.

### Sensor type 318

Use the provided strap to fasten the sensor to the supply pipe. Alternatively, type 318 can be inserted in any temperature well with a minimum inside diameter of 7/32" (5.5 mm) and a depth of 1-9/16" (40mm). Do not submerge the sensor itself into a liquid. For other temperature sensor options, see data brochure D 05. Connect this sensor's two wires to the appropriate terminals of the base.

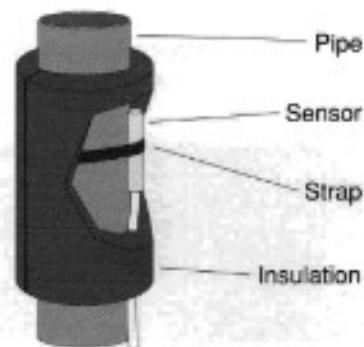

## Settings

### Type 226 settings

#### Setpoint, type 226

Determine from the table below or from the one on the front of the control whether S1 or S2 will be the range used. Connect the sensor to the appropriate terminals (S1 & Cs or S2 & Cs). From the table, determine the setting (1 to 14) that corresponds to the desired temperature. Rotate the setpoint dial to this setting number.

Dial Setting	Terminal S1		Terminal S2		Dial Setting	Terminal S1		Terminal S2	
	°F	°C	°F	°C		°F	°C	°F	°C
0	-2	-19	70	21	8	62	17	150	66
1	6	-14	80	27	9	70	21	160	71
2	14	-10	90	32	10	78	26	170	77
3	22	-6	100	38	11	86	30	180	82
4	30	-1	110	43	12	94	34	190	88
5	38	3	120	49	13	102	39	200	93
6	46	8	130	54	14	110	43	210	99
7	54	12	140	60					

### Differential (Diff'I), type 226

The differential adjustment sets how much the actual sensor temperature may deviate from the desired temperature before the relay is turned on or off. The range of adjustment is from  $\pm 1^{\circ}\text{F}$  ( $\pm 0.5^{\circ}\text{C}$ ) to  $\pm 11^{\circ}\text{F}$  ( $\pm 6^{\circ}\text{C}$ ).

### Delay (I), type 226

When terminal I (14) is shorted to Cs (13) then Relay #2 will turn off 3 minutes after the sensor is warm enough instead of immediately. This relay could be operating a pump which will run for 3 minutes after a boiler has turned off in order to purge the remaining heat from the boiler.

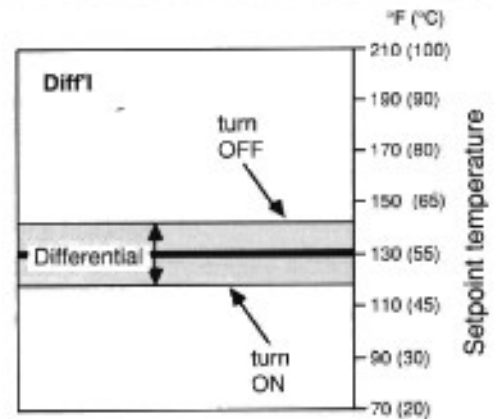

### Lead/Lag, type 226

The setpoint is the centre of the operating range of Relay #2. By the lead/lag adjustment the centre of the operating range of Relay #1 can be set as much as  $15^{\circ}\text{F}$  ( $8^{\circ}\text{C}$ ) warmer (lead) or cooler (lag) than the setpoint. For example, if the lead/lag adjustment is set to  $-15^{\circ}\text{F}$  ( $-8^{\circ}\text{C}$ ) and the sensor is becoming cooler, then Relay #2 turns on at the setpoint less differential and Relay #1 turns on when the sensor becomes  $15^{\circ}\text{F}$  ( $8^{\circ}\text{C}$ ) cooler than that point.

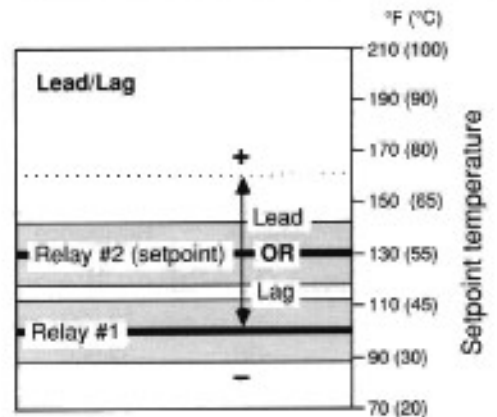

### Type 227 settings

#### Setpoint, type 227

Determine from the table below or from the one on the front of the control whether S1 or S2 will be the range used. Connect the sensor to the appropriate terminals (S1 & Cs or S2 & Cs). From the table, determine the setting (1 to 14) that corresponds to the desired temperature. Rotate the setpoint dial to this setting number.

Dial Setting	Terminal S1		Terminal S2		Dial Setting	Terminal S1		Terminal S2	
	$^{\circ}\text{F}$	$^{\circ}\text{C}$	$^{\circ}\text{F}$	$^{\circ}\text{C}$		$^{\circ}\text{F}$	$^{\circ}\text{C}$	$^{\circ}\text{F}$	$^{\circ}\text{C}$
0	14	-10	104	40	8	76	24	176	80
1	22	-6	113	45	9	83	29	185	85
2	29	-1	122	50	10	91	33	194	90
3	37	3	131	55	11	99	37	203	95
4	45	7	140	60	12	107	41	212	100
5	53	11	149	65	13	114	46	221	105
6	60	16	158	70	14	122	50	230	110
7	68	20	167	75					

### Neutral Zone (NZ) type 227

The Neutral Zone is a measure of how much the actual supply water temperature may deviate from the desired temperature before the mixing valve is adjusted. Generally the Neutral Zone is set to  $\pm 1^{\circ}\text{F}$  ( $\pm 0.5^{\circ}\text{C}$ ). In the event of unsteady mixing valve behavior, increase the Neutral Zone. The range of adjustment is  $\pm 1^{\circ}\text{F}$  ( $\pm 0.5^{\circ}\text{C}$ ) to  $\pm 11^{\circ}\text{F}$  ( $\pm 6^{\circ}\text{C}$ ).

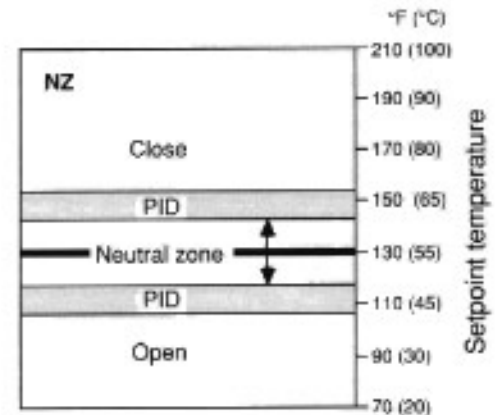

### PID disable (I), type 227

When terminal I (9) is shorted to Cs (14) then the control function is only proportional.

## Testing and Troubleshooting

**Do not plug the control into the base until the following tests have been performed. If any of the following tests fail, check the wiring to and from the base.**

### Step 1 Test the sensors

Using an ohmmeter, measure the resistance between the terminals as shown in table 1. Table 4 lists the expected resistance values at various sensor temperatures. The resistance between ground (the pipes), and any of terminals 9 to 16 should be greater than 1,000,000 ohms. No voltage should be present between any of these terminals and ground.

### Step 2 Test the power supply

Turn on power to the transformer. Using an AC voltmeter, measure the voltage between terminals 1 & 2. The voltage should be between 16 and 28 volts AC.

### Step 3 Test the Control

Set the control adjustments according to the instructions on page 3. Plug the control in. On control type 227 the lamp "On" will light. Disconnect the temperature sensor from the terminals. With an ohmmeter, test for a short circuit (0 ohms) between the terminals listed in table 2. Now place a short across the sensor input terminals and test for a short circuit between the terminals listed in table 3.

Control	Terminals
type 226	13 & 16 (S1) or 13 & 15 (S2)
type 227	14 & 16 (S1) or 14 & 15 (S2)

table 1

Control	Terminals
type 226	4 & 5, 7 & 8 (Relays 1 & 2 on)
type 227	4 & 5 (lamp "O" is on)

table 2

Control	Terminals
type 226	3 & 4, 6 & 7 (Relays 1 & 2 off)
type 227	4 & 6 (lamp "C" is on)

table 3

Sensor temperature			Resistance			Sensor temperature			Resistance		
°F	°C	Ω	°F	°C	Ω	°F	°C	Ω	°F	°C	Ω
-50	-45	59,000	50	10	3,700	150	65	500			
-30	-35	33,000	70	20	2,400	170	76	360			
-10	-23	17,000	90	32	1,500	190	88	250			
10	-12	10,000	110	43	1,000	210	100	180			
30	0	5,600	130	54	720	230	110	140			

table 4

## Limited Warranty and Product Return Procedure

**Limited Warranty:** tekmar warrants to the original purchaser each tekmar product against defects in workmanship and materials when the product is installed and used in compliance with tekmar's instructions. This limited warranty covers the cost of parts and labour provided by tekmar to correct defects in materials and/or workmanship. Returned products that are fully operational are not considered a warranty case. tekmar also does not cover parts or labour to remove, transport or reinstall a defective product. tekmar will not be liable for any damage other than repair or replacement of the defective part or parts and such repair or replacement shall be deemed to be the sole remedy from tekmar. This warranty shall not apply to any defects caused or repairs required as a result of unreasonable or negligent use, neglect, accident, improper installation, or unauthorized repair or alterations. In case of defect, malfunction or failure to conform to warranty, tekmar will, for a warranty period of 24 months from the date of invoice to the original purchaser or 12 months from the date of installation of the product, whichever occurs first, repair, exchange or give credit for the defective product. Any express or implied warranty which the purchaser may have, including merchantability and fitness for a particular purpose, shall not extend beyond 24 months from the date of invoice or 12 months from the date of installation of the product, whichever occurs first.

**Replacements:** tekmar can send replacement products if requested. All replacements are invoiced. Any possible credit for the replacement will only be issued once the replaced product has been returned to tekmar.

**Product Return Procedure:** Products that are believed to have failed must be returned to tekmar Control Systems Ltd. 4611-23rd Street, Vernon B.C. Canada V1T 4K7 when agreed to by tekmar. The installer or other qualified service person must, at the owner's expense, determine which component has failed. The product must be returned complete with

all of its components (sensors, base, etc.). Products must be returned together with the proof of purchase to the original purchaser who then returns the product to tekmar after receiving a Return Goods Authorization (RGA) number from tekmar.

Please include the following information with the product. The full address of the original purchaser, the RGA number and a description of the problem.

From the U.S.A., in order to avoid customs charges, products must be returned via US Post with the package clearly marked with the RGA number, product type and the statement "Canadian Product returned for repair". For shipping purposes the product can be valued at one half list price.

- 1) If returned during the warranty period and the product is defective, tekmar will issue full credit for the returned product less cost of missing parts.
- 2) If returned during the warranty period and the product is fully operational, tekmar will return the product to the original purchaser for a testing cost of \$30.00 plus postage.
- 3) If returned during the warranty period and the product is not damaged and is fully operational, tekmar can take back the product for a return charge of 40% of the product's net value. This request has to be specified otherwise the product will be returned with a testing cost of \$30.00 plus postage.
- 4) If returned after the warranty period and the product needs repair, tekmar will repair and return the product. Repair and postage costs will be invoiced. tekmar's repair costs are calculated at \$30.00 / hour plus the cost of parts. If the repair costs will be more than \$60.00 a repair estimate will be sent to the original purchaser.

**In North America:** tekmar Control Systems Ltd., Canada  
tekmar Control Systems, Inc., U.S.A.  
Head Office: 4611 - 23rd Street  
Vernon, B.C. Canada V1T 4K7  
Tel. (604) 545-7749 Fax. (604) 545-0650

