

# tekmar® - Data Brochure

Snow Detector & Melting Control 662

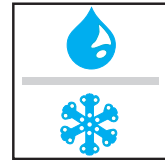

D 662

07/99

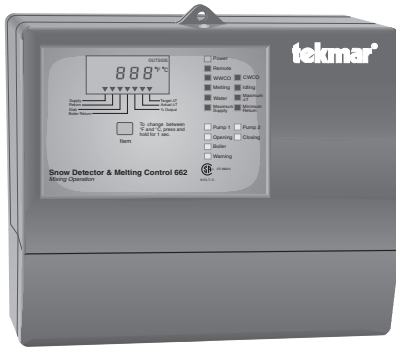

The tekmar Snow Detector & Melting Control 662 is a microprocessor-based control which, together with the Snow/Ice Sensor 090, activates and controls the rate of heat delivery to a snow melt system. This versatile control has three modulating outputs to control the heat delivery for most pump and/or valve arrangements. Protection of both the snow melt slab and the boiler is achieved through several safety features. Faster pick up times are also ensured through a viscosity compensation function which optimizes the rate of heat delivery to the slab during start up. The 662 combines all the necessary features to make snow melting safe and trouble free.

<b>Sequence of Operation</b> . . . . .	<b>pg. 2</b>	<b>Testing</b> . . . . .	<b>pg. 9</b>
<b>Installation</b> . . . . .	<b>pg. 3</b>	<b>Error Messages</b> . . . . .	<b>pg. 10</b>
<b>Settings</b> . . . . .	<b>pg. 7</b>	<b>Technical Data</b> . . . . .	<b>pg. 12</b>
<b>Display Operation</b> . . . . .	<b>pg. 8</b>	<b>Limited Warranty</b> . . . . .	<b>pg. 12</b>

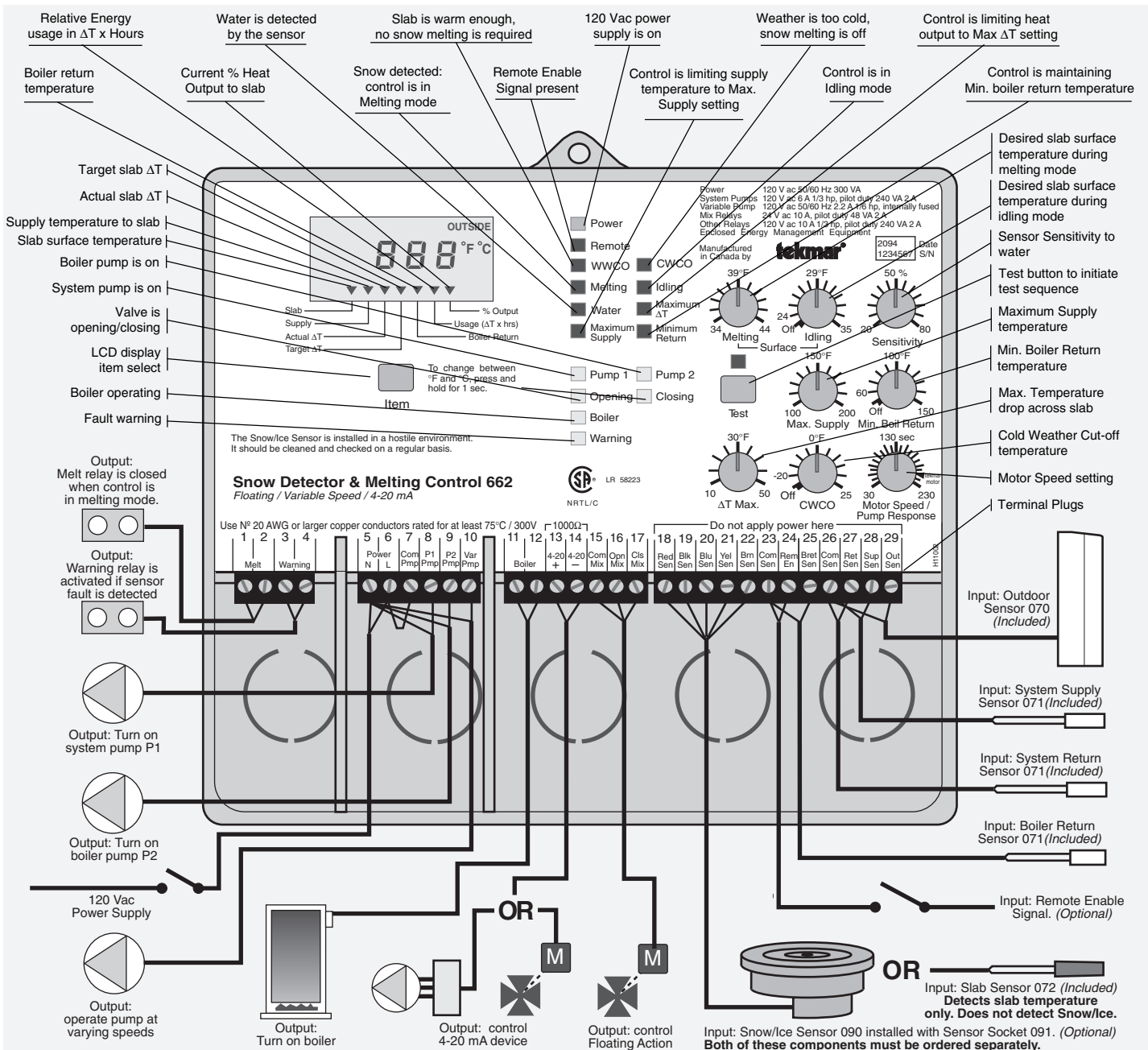

In order for this control to operate effectively, it must be installed in a well designed melting system. The Application Brochures A 662 provide a series of schematics which can be used with this control. Any deviations from these drawings **must** be discussed with a tekmar factory representative to ensure that system performance is not compromised. The application drawings are **not** final designs - each component within the system must be correctly sized for the control to operate effectively. It is important that the sequence of operation and the application drawings for this control are fully understood to ensure that the control selected is compatible with its intended use.

## Sequence of Operation

### Powering up the control

After the Snow Detector & Melting Control 662 is powered up, the red status lights and the LCD segments are turned on for 7 seconds. The control then displays the "Outdoor" temperature.

### Melting Mode

**Operation using a Snow/ Ice Sensor 090** - The control continually monitors the Snow/Ice Sensor 090. When water is detected, the "Water" light turns on and if the control is not in WWCO or CWCO (see page 3 for an explanation of these terms), melting mode begins.

**Operation using a Remote Enable** - Melting mode can also be initiated if a remote enable signal is present (terminals Com Sen and Rem Sen shorted together) and the control is not in WWCO or CWCO. The remote enable is typically used with multiple Snow Melting Controls and Snow/Ice Sensors. It can be also be used to manually turn the melting system on by wiring a switch between the remote terminals. **A remote enable switch must be installed when a Slab Sensor 072 is used** as this sensor cannot detect water.

Once the control is in melting mode, the Melting relay and boiler pump (relay P2 Pmp) are turned on. After a 4 second delay, the system pump (relay P1 Pmp) is turned on and after 8 seconds, heat is applied to the snow melt system through either a variable speed pump, a floating action mixing valve or a 4-20 mA device. The opening and closing lights indicate whether the control is increasing or decreasing the heat applied to the snow melt system. Essay E 021 compares the use of these devices for controlling the system temperature and also discusses the sizing and operation of the variable speed pump. Information on floating action can be found in Essay E 000. The 4-20 mA, variable speed pump and mixing valve outputs operate simultaneously. The 4-20 mA output can therefore be used to provide a remote readout of the pump or valve operation. The control remains in melting mode until no water is detected for at least 30 seconds and the slab is up to temperature for at least 30 minutes. Cold Weather or Warm Weather Cut Off can also terminate melting mode. When the control exits melting mode the boiler and system pumps are operated for an additional 90 seconds to purge the boiler. If the control switches from melting to idling mode, the boiler is not purged.

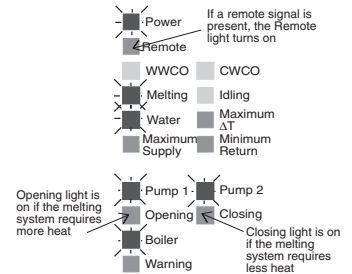

### Idling Mode

When the melting system starts off from a cold temperature, the time required for the slab to reach "Melting" temperature can be excessive. To decrease this start up time, the slab can be maintained at an "Idling" temperature until melting is required. The idling feature is also useful for preventing frost and light ice formation. When the control is in idling mode, control operation is similar to melting mode except the "Melting" and "Water" lights are off and the "Idling" light is on.

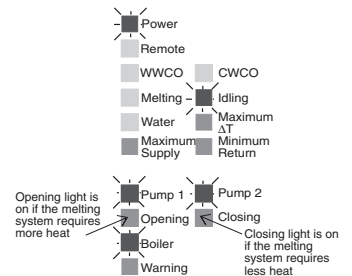

### Snow melt system protection features

The 662 control has several features for protection of the snow melt system:

- to protect the slab from cracking due to thermal stresses, the control limits the rate of heat applied to the slab through a "ΔT Max" setting. The ΔT represents the difference between the slab supply and return fluid temperatures which are measured by the control. If this temperature difference approaches the "ΔT Max" setting, the "Maximum ΔT" light turns on and the control operates the valve or pump to maintain the ΔT at the "ΔT Max" setting.
- to protect the piping and other components in the system, the control limits the supply temperature to a "Max. Supply" setting. When the melt system supply temperature approaches the maximum supply setting, the "Maximum Supply" light turns on and the control operates the valve or pump to reduce the supply temperature.
- to prevent the flue gases in the boiler from condensing, the control limits the boiler return temperature to a "Min. Boil. Return" setting. When the boiler return temperature approaches this setting, the "Minimum Return" light turns on and the control operates the valve or pump to increase the boiler return temperature.

### ΔT compensation for changes in fluid viscosity

Glycol solutions used in snow melt systems have widely varying viscosities between high and low temperatures. As the glycol solution temperature drops, viscosity increases causing a reduction in flow rate. This reduction in flow rate reduces the rate of heat output if the fluid temperature drop across the slab (ΔT) remains constant. To compensate for this, the control increases the Maximum ΔT. This compensation is only applied when the fluid temperature is below 30°F, which is the temperature at which the viscosity of a typical 40% ethylene glycol / 60% water solution starts to increase significantly. The compensation feature is designed for fluids containing 40% ethylene glycol or 30% propylene glycol; however, if the glycol percentage in the solution is lower than these values, the quality of heat regulation is not significantly affected. When the control is compensating for viscosity changes, the "Maximum ΔT" light flashes.

### Ramping the ΔT during melting system start up

When the control turns on the melting system, the "Target ΔT" is slowly ramped up to the maximum ΔT to prevent thermal shock of the slab. If the temperature of the fluid returning to the boiler (source) is sufficient, the ramping time is less than 17 minutes. If the heat source is not dedicated to snow melting and there are other heat demands on the source, the ramping time may be longer.

## Warm Weather Cut Off (WWCO)

If the “Slab” and “Outdoor” temperatures rise above the “Melting” temperature, heating the slab is no longer required. The control therefore shuts down the melting system and enters WWCO. During WWCO the “Closing” light remains on continuously and the heat supplied through the valve or variable speed pump is reduced to zero. When the “Outdoor” or “Slab” temperature drops below the “Melting” temperature, the control exits WWCO and continues with normal operation.

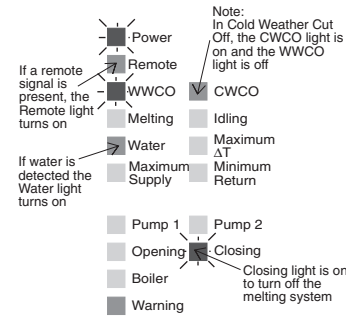

## Cold Weather Cut Off (CWCO)

Maintaining the slab at a “Melting” or “Idling” temperature in extremely cold weather can be expensive and may even be impossible. When it does snow at these colder temperatures, the snow is usually dry, light and less slippery. The control therefore turns the melting system off when the “Outdoor” temperature drops below the “CWCO” setting. During CWCO the “Closing” light remains on continuously and the heat supplied through the valve or pump is reduced to zero. The heater in the Snow/ Ice Sensor 090 is kept on during CWCO until the control detects snow. If snow is detected, the heater is turned off but the control retains the snow detected information. When the outdoor temperature rises above the “CWCO” temperature, the control exits CWCO and if the Snow/Ice Sensor 090 detected snow during CWCO, the control initiates melting mode.

## Warning Light and Relay

If a sensor fault occurs, the Warning relay and light are turned on and an error message is given. The look-up table provided on pages 10 and 11 can be used to determine which sensor has the fault.

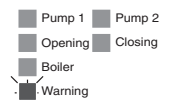

## Exercising of the Pumps and Valves

To prevent the pumps or valves from seizing after long inactive periods, the pumps and valves are operated after every 3 days of no operation. The Pump P1 and Pump P2 relays are turned on for 20 seconds and the mixing valve or variable speed pump output is run fully open and/or fully closed. During exercising, the LCD screen alternates between two special characters as illustrated in the diagram.

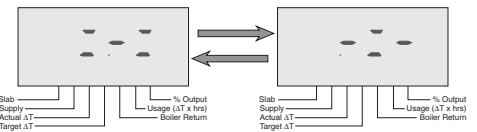

## Installation

### Caution

**Improper installation and operation of this control could result in damage to equipment and possibly even personal injury. It is your responsibility to ensure that this control is safely installed according to all applicable codes and standards. This electronic control is not intended for use as a primary limit control. Other controls that are intended and certified as safety limits must be placed into the control circuit.**

### Step One ■■■■ Getting ready ■■■■

Check the contents of this package. If any of the contents listed are missing or damaged, please refer to the Limited Warranty and Product Return Procedure on the back of this brochure and contact your wholesaler or tekmar sales agent for assistance.

Type 662 includes:

- One Snow Detector & Melting control 662
- One Outdoor Sensor 070
- Three Universal Sensors 071
- One Slab Sensor 072
- One Data Brochure D 662
- Application Brochures A 662
- One Data Brochure D 001

Other information available: • Essay E 021 • Essay E 000 • Essay E 600

Read Brochures A 662 and select the correct Application for your job.

**Note: This control can be installed with EITHER a Snow/Ice Sensor 090 and Sensor Socket 091 OR a Slab Sensor 072. The Snow/Ice Sensor 090 and Sensor Socket 091 are not included with the type 662 and must be ordered separately.**

*Carefully read the details of the Sequence of Operation sections in all applicable brochures to ensure that you have chosen the proper control and understand its functions within the operational requirements of your system.*

### Step Two ■■■■ Mounting of the base ■■■■

The control should be removed from its base by pressing down on the release clip in the wiring chamber and sliding upwards on the control. The base is then mounted in accordance with the instructions in the Data Brochure D 001.

### Step Three ■■■■ Rough-in Wiring ■■■■

All electrical wiring terminates in the control base wiring chamber. It has standard 7/8" (22mm) knock-outs that accept all common wiring hardware and conduit fittings. Before breaking out the knock-outs, check the wiring diagram and select those sections of the chamber with common voltages. Do not allow the wiring to cross over sections as safety dividers, installed later, prevent this.

**Power should not be applied to any of the wires during the rough-in wiring stage.**

- **EITHER:** Install the Snow/Ice Sensor 090 according to the instructions in Data Brochure D 090 and run the wiring back to the base. See Data Brochure 090 for very important details on sensor location and installation.
- **OR:** Install the Slab Sensor 072 according to the instructions in the Data Brochure D 001 and run the wiring back to the base. See page 5 for very important details on sensor location and installation.
- Run the wiring from the other system components to the base.
- Run 120 V ac to the power terminals on the control. Use a clean 120 V ac power source to ensure proper operation.
- Multi-strand 16 AWG wire is recommended for the 120 V ac wiring due to its superior flexibility and ease of installation into the terminal.

## Step Four Electrical connections to the control

### Power and output connections

- The installer should test to confirm no voltage is present at any of the wires.
- Install the control back into the base by sliding it down until it snaps in firmly.
- Connect the 120 V ac power supply to terminals *Power N — L* (5 and 6).

5	6	7	8	9	10
Power	Com	P1	P2	Var	
N	L	Pmp	Pmp	Pmp	Pmp

### Melt Output

- Connect the melting device to terminals *Melt* (1 and 2). These terminals lead to an unpowered (dry) relay contact inside the control which closes when the control enters melting mode. The most common devices to be enabled by the 662 are pumps, heating devices or other controls.

1	2	3	4
Melt		Warning	

### Warning

- If desired, connect a warning device to terminals *Warning* (3 and 4). These terminals lead to a dry relay contact inside the control which closes when there is a sensor or wiring fault.

**Caution: The 662 is an operating control and is not certified as a safety device. If safety considerations are critical, a separate alarm system must be installed.**

1	2	3	4
Melt		Warning	

### Pump Power Supply

- Terminal *Com Pmp* (7) is the common power supply terminal for both terminals *P1 Pmp* (8) and *P2 Pmp* (9).
- If the pumps P1 and P2 are operated from the same 120 V ac power supply as the control, connect the terminal *Power L* (6) to the terminal *Com Pmp* (7).
- If a separate power supply is required for P1 and/or P2, contact tekmar for details.

5	6	7	8	9	10
Power	Com	P1	P2	Var	
N	L	Pmp	Pmp	Pmp	Pmp

### System Pump P1

- Connect the System Pump to terminals *Power N — P1 Pmp* (5 and 8). These terminals lead to a dry relay contact which closes when the control requires System Pump operation.

5	6	7	8	9	10
Power	Com	P1	P2	Var	
N	L	Pmp	Pmp	Pmp	Pmp

### Boiler Pump P2

- Connect the Boiler Pump to terminals *Power N — P2 Pmp* (5 and 9). These terminals lead to a dry relay contact which closes when the control requires Boiler Pump operation.

5	6	7	8	9	10
Power	Com	P1	P2	Var	
N	L	Pmp	Pmp	Pmp	Pmp

### Variable Speed

- Connect the variable speed pump to terminals *Power N — Var Pmp* (5 and 10). Pumps operated by this circuit must be permanent capacitor, impedance protected with a locked rotor current less than 2.2 amps. The Snow Detector & Melting Control 662 has an internal 2.5 amp fuse for overload protection. *This fuse is not field replaceable.* Contact tekmar for details on return and repair procedures if this fuse is blown.

5	6	7	8	9	10
Power	Com	P1	P2	Var	
N	L	Pmp	Pmp	Pmp	Pmp

### Boiler

- Connect the boiler or the boiler control to the terminals *Boiler* (11 and 12). These terminals lead to a dry relay contact which closes when the control requires boiler operation.

11	12	13	14	15	16	17
Boiler		4-20 +	4-20 -	Com Mix	Opn Mix	Cls Mix

### 4-20 mA Device

- Connect the positive 4 - 20 mA lead to terminal *4-20 +* (13) and the negative 4 - 20 mA lead to terminal *4-20 -* (14). Maximum resistance allowed in the 4 - 20 mA circuit is 1000  $\Omega$ . The 4 - 20 mA output can be converted to a voltage output by connecting a resistor between terminals 13 and 14.

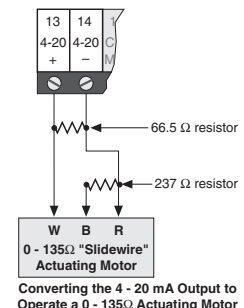
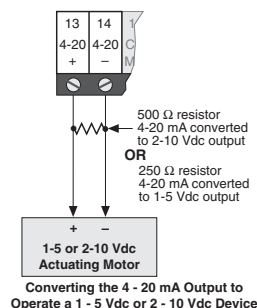
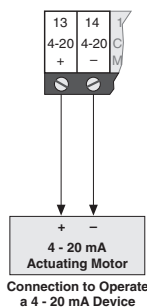

### Floating Action Mixing Valve

- Connect one side (R) of a 24 V ac transformer to terminal *Com Mix* (15).
- Connect the (C) side of the transformer to terminal *N/C* on the tekmar 010 Actuating Motor. *For other makes of actuating motors, refer to the manufacturers' installation instructions.*
- Connect the OPEN terminal of the Actuating Motor (CCW) to the terminal *Opn Mix* (16) on the control. This terminal leads to a relay contact which closes to provide 24 V ac to open the valve.
- Connect the CLOSE terminal of the Actuating Motor (CW) to the terminal *Cls Mix* (17) on the control. This terminal leads to a relay contact which closes to provide 24 V ac to close the valve.

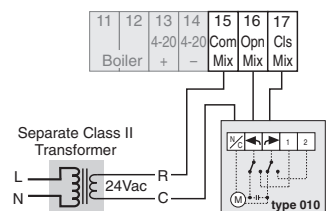

Sensor and unpowered input connections

**Power should never be applied to these terminals. Damage to the control will result.**

**Snow/Ice Sensor 090 (Must be ordered separately)**

For automatic detection of snow or ice, the tekmar Snow/Ice Sensor 090 is required. This sensor must be installed flush with the slab surface and 1/2 way between the heating pipes. See Data Brochure D 090 for installation instructions regarding the Snow/Ice Sensor 090 and Sensor Socket 091.

- Connect the red wire from the sensor cable to terminal *Red Sen* (18).
- Connect the black wire from the sensor cable to terminal *Blk Sen* (19).
- Connect the blue wire from the sensor cable to terminal *Blu Sen* (20).
- Connect the yellow wire from the sensor cable to terminal *Yel Sen* (21).
- Connect the brown wire from the sensor cable to terminal *Brn Sen* (22).

18	19	20	21	22	23
Red Sen	Blk Sen	Blu Sen	Yel Sen	Brn Sen	Com Sen

**Slab Sensor 072**

If a Snow/Ice Sensor 090 is not ordered, the Slab Sensor 072 must be installed. *With the 072 sensor, a remote enable switch turns the melting system on.* Connect the two sensor wires to terminals *Blk Sen — Brn Sen* (19 and 22). The 072 sensor cable is 20 feet (6m) long but it can be extended to a maximum overall length of 1000 feet (300 m). If extension becomes necessary, splices should be properly soldered and waterproofed and be protected in an accessible, waterproof junction box. Use at least 18 AWG wire for extensions.

**Important Note:** Proper sensor placement is critical for correct operation of the 662 control. The Slab Sensor 072 must be installed *1/2 way between the heating pipes and 1" (25 mm) below the surface of the slab.* Although the 072 sensor can be placed directly into the slab, we recommend that the sensor be installed in tubing or conduit in such a manner that the sensor can be removed and replaced in case of failure.

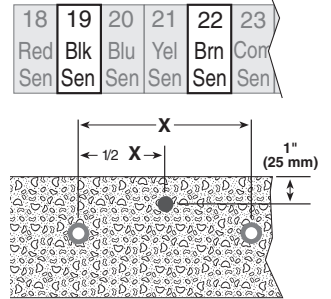

**Outdoor Sensor**

- Connect the two wires from the Outdoor Sensor 070 to the terminals *Com Sen — Out Sen* (26 and 29).

18	19	20	21	22	23	24	25	26	27	28	29
Red Sen	Blk Sen	Blu Sen	Yel Sen	Brn Sen	Com Sen	Rem En	Bret Sen	Com Sen	Ret Sen	Sup Sen	Out Sen

**System Supply Sensor**

- Connect the two wires from the Universal Sensor 071 – which should be mounted on the system supply pipe to the slab – to terminals *Com Sen — Sup Sen* (26 and 28).

18	19	20	21	22	23	24	25	26	27	28	29
Red Sen	Blk Sen	Blu Sen	Yel Sen	Brn Sen	Com Sen	Rem En	Bret Sen	Com Sen	Ret Sen	Sup Sen	Out Sen

**System Return Sensor**

- Connect the two wires from the Universal Sensor 071 – which should be mounted on the system return pipe from the slab – to terminals *Com Sen — Ret Sen* (26 and 27).

18	19	20	21	22	23	24	25	26	27	28	29
Red Sen	Blk Sen	Blu Sen	Yel Sen	Brn Sen	Com Sen	Rem En	Bret Sen	Com Sen	Ret Sen	Sup Sen	Out Sen

**Boiler Return Sensor**

- Connect the two wires from the Universal Sensor 071 – which should be mounted on the return pipe to the boiler – to terminals *Com Sen — Bret Sen* (23 and 25).

18	19	20	21	22	23	24	25	26	27	28	29
Red Sen	Blk Sen	Blu Sen	Yel Sen	Brn Sen	Com Sen	Rem En	Bret Sen	Com Sen	Ret Sen	Sup Sen	Out Sen

**Remote Enable Signal (Optional)**

- If a remote device is used to enable the control, connect the two wires from the device to terminals *Com Sen — Rem Sen* (23 and 24).

18	19	20	21	22	23	24	25	26	27	28	29
Red Sen	Blk Sen	Blu Sen	Yel Sen	Brn Sen	Com Sen	Rem En	Bret Sen	Com Sen	Ret Sen	Sup Sen	Out Sen

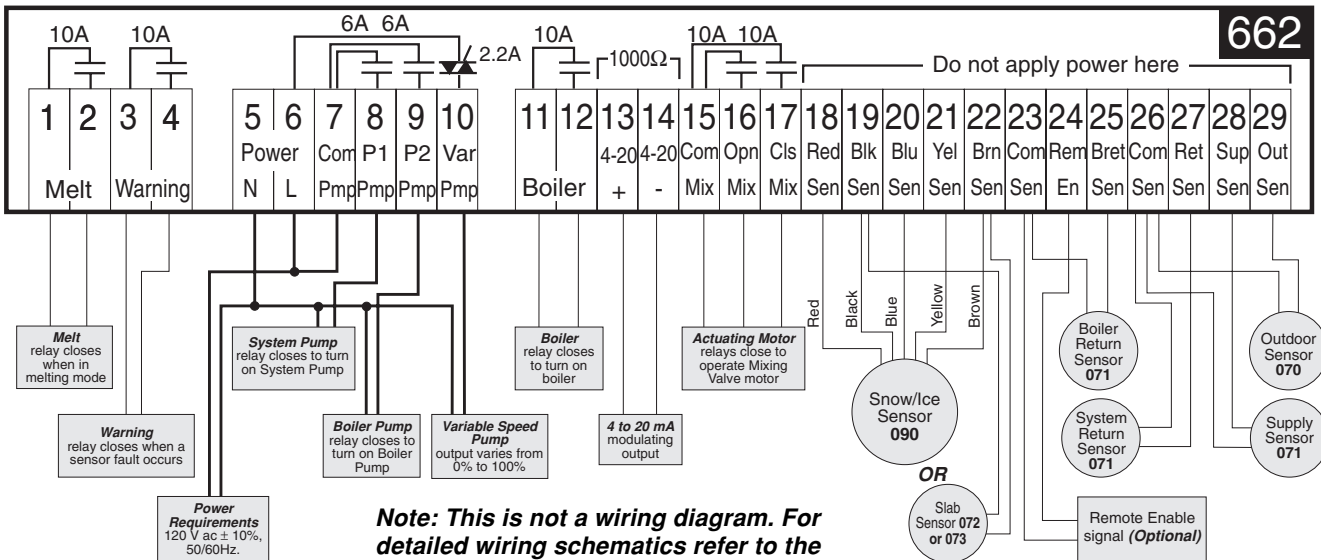

**Note: This is not a wiring diagram. For detailed wiring schematics refer to the Application Brochures A 662.**

## Step Five Testing the wiring

- Before applying power to the control for testing, each terminal plug **must** be unplugged from its header on the control. Pull straight down to unplug.
- These tests are to be performed using standard testing practices and procedures and should only be carried out by properly trained and experienced persons.
- A good quality electrical test meter capable of reading from at least 0 — 200 Volts ac, and at least 0 — 2,000,000 Ohms, is essential to properly test this control.

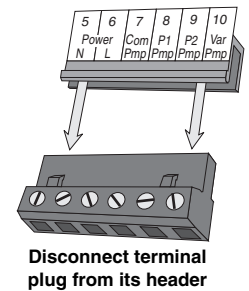

### Test the sensors

- In order to test the sensors, the actual temperature at each sensor must be known. A good quality digital thermometer with a surface temperature probe is recommended for ease of use and accuracy of testing. Where a thermometer is not available, a spare sensor can be strapped alongside the one to be tested and the readings compared. Test the Snow/Ice Sensor 090 according to the instructions in brochure D 090, and the remaining sensors according to the brochure D 001.

### Test the power supply

- Before applying power, make sure exposed wiring or terminals are not grounded or in contact with other wires. Turn on the 120 V ac power and, using an AC voltmeter, measure the voltage between terminals *Power N – L* (5 and 6). You should measure between 110 and 130 V ac.

### Test the Outputs

- If a device is connected to the *Melt* (1 and 2) terminals, make sure power to the circuit is off and install a jumper in the terminal plug between terminals 1 and 2. When the device is powered up, it should operate. If it does not turn on, check the wiring from the terminal plug to the device and refer to any installation or trouble shooting information supplied with the device. If the device is operating properly, disconnect the power and remove the jumper.
- Repeat this procedure for any devices connected to the *Warning* (3 and 4) terminals and the *Boiler* (11 and 12) terminals.
- If a pump is connected to the *P1 Pmp* (8) terminal, make sure power to the circuit is off and install a jumper in the terminal plug between the *Com Pmp – P1 Pmp* (7 and 8) terminals. When the circuit is powered up, the pump should start. If it does not, check the wiring from the terminal plug to the pump and refer to any installation or troubleshooting information supplied with the pump. If the pump operates properly, disconnect the power and remove the jumper. Repeat this procedure for a pump connected to the *P2 Pmp* (9) terminal.
- If a variable speed pump is connected to the *Power N – Var Pmp* (5 and 10) terminals, make sure power to the circuit is off and install a jumper in the terminal plug between the *Power L – Var Pmp* (6 and 10) terminals. When the 120 V ac circuit is powered up, the variable speed pump should operate at full speed. If it does not, check the wiring from the terminal plug to the pump and refer to any installation or troubleshooting information supplied with the pump. If the pump operates properly, disconnect the power and remove the jumper.
- A separate 24 V ac transformer is used to drive the actuating motor for the mixing valve. Make sure power to the transformer is off and install a jumper in the terminal plug between terminals *Com Mix – Opn Mix* (15 and 16). When the transformer is powered up, the mixing valve should drive fully open and then stop. Turn off the power to the transformer, remove the jumper and install it in the terminal plug between terminals *Com Mix – Cls Mix* (15 and 17). When the transformer is powered up, the mixing valve should drive fully closed and then stop. If it does, disconnect the power and remove the jumper.
- The 4 - 20 mA output terminals (13 and 14) cannot be tested without power applied to the control. Since no power is supplied to the control at this point, the 4 - 20 mA output cannot be tested. Please refer to the operation test below.

### Connect the control

- **Turn the power off and make sure all test jumpers have been removed from the plugs.**
- Connect the plugs to the control by carefully aligning them with their respective headers and pushing them upwards. The plugs should snap firmly into the headers.
- Install the supplied safety divider(s) between the low voltage (less than 30 V ac) and the line voltage (120 V ac) wiring chambers. Apply power to the control.

### Test the 4 - 20 mA output

The 4 - 20 mA device can be tested as follows:

- Connect the positive wire from the 4 - 20 mA device to terminal 13 on the control.
- Connect the negative wire from the 4 - 20 mA device to the red (+) lead on the milliamp meter.
- Connect the black (-) lead from the milliamp meter to terminal 14 on the control.
- When the Opening light turns on, the initial percentage output is zero and the meter should read 4 mA.
- As the % Output increases, the meter reading should increase until 100% Output is reached at which point the meter should read 20mA.
- When the Closing light comes on the meter should start at 20mA and eventually reach 4mA when the display shows 0% Output.

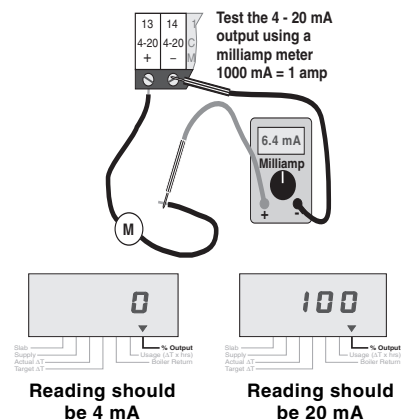

## Settings

### Step Six Essential control settings

Before adjusting the dial settings, read through the sequence of operation to ensure that you understand how the control operates. The dials are factory set at the midpoint of each setting. This reflects typical settings for many systems and is therefore a good starting point.

#### Melting Surface Temperature

The “Melting” dial setting is the desired slab surface temperature when the control is in melting mode and is also used as the Warm Weather Cut Off temperature. The “Melting” temperature is usually set based on local weather conditions. In some areas, heavy snowfall can load a slab at temperatures well above freezing; in these areas, the dial should be set higher. If the melting system response is sluggish, increasing the “Melting” dial setting can cause the system to melt faster; however, it is important to remember that increasing this setting generally increases energy consumption.

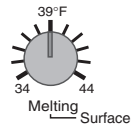

#### Idling Surface Temperature

The “Idling” dial setting is based on the requirements of the user. If minimizing the time required for the slab to reach “Melting” temperature is important then the dial is set slightly below freezing (<32°F). If black ice or frost formation is a concern, the dial is set slightly above freezing (>32°F). It is important to remember that “Idling” increases energy consumption. “Idling” can also be turned Off.

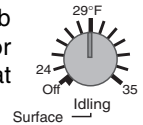

#### Water Detection Sensitivity

The sensitivity of the Snow/Ice Sensor to water can be adjusted using the “Sensitivity” dial. As snow becomes contaminated with dirt, and as the sensor surface itself becomes dirty, the control may incorrectly indicate the presence of water. If this condition occurs, clean the surface of the sensor and/or turn down the sensitivity setting. If the snow and rain in your area is very clean, the sensitivity setting may need to be increased before snow is detected.

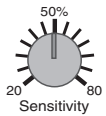

**Note: The Snow/Ice Sensor 090 is installed in a hostile environment and should be cleaned on a regular basis with a wire brush. After cleaning, check operation by pressing the test button to cycle the control through the test routine.**

#### Maximum Supply Temperature

Some tubing manufacturers recommend that their products not be operated continuously at temperatures greater than 140°F (60°C). Engineers also recommend that concrete slabs not be subjected to temperatures in excess of 160°F (70°C). This dial setting permits the installer to limit the maximum temperature of the water supplied to the snow melting slab. If the system supply water temperature approaches this setting, the “Maximum Supply” light turns on and the control operates the mixing valve (or variable speed pump) to limit the output and reduce the “Supply” temperature.

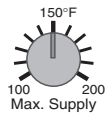

#### Minimum Boiler Return Temperature

To prevent problems of flue gas condensation in the boiler, this adjustment is set to the minimum boiler return temperature as specified by the boiler manufacturer. When the boiler return approaches this setting, the “Minimum Return” light turns on and the control operates the mixing valve (or variable speed pump) to limit the output until the boiler return can warm up. If a minimum boiler return temperature is not required, as with condensing or electric boilers, this adjustment can be set to “Off”.

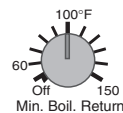

#### $\Delta T$ Max. (Maximum Rate of Heat Delivery)

The 662 control limits the rate of heat applied to a slab to prevent excessive thermal stress. The rate of heat delivery to the slab is dependant on the difference between the melting system supply and return temperatures. The control measures these temperatures and calculates the difference to give the  $\Delta T$ . If this calculated  $\Delta T$  approaches the “ $\Delta T$  Max” setting, the control operates the valve or pump to maintain the  $\Delta T$  at the “ $\Delta T$  Max” setting. The “ $\Delta T$  Max” dial is normally set at 5°F to 10°F above the design  $\Delta T$  or it is specified directly by the system designer. If this is not the case, set the dial at 30°F.

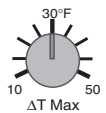

Note: The control may exceed its “ $\Delta T$  Max” setting if the supply temperature is lower than 30°F (see page 2 —  $\Delta T$  compensation for changes in fluid viscosity).

#### CWCO (Cold Weather Cut Off)

The “CWCO” is the lowest temperature at which the melting system continues to operate. This temperature is set based on the capacity of the snow melt system and the economics of melting in extreme conditions.

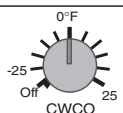

#### Motor Speed / Pump Response

**Pump Response (variable speed pump)** - When using a variable speed pump, this dial sets the minimum time required for the injection pump to go from 0% to 100% speed (ramp up). The primary purpose of limiting the pump ramp up time is to avoid instability. If the pump ramps up faster than the snow melt system can respond, the pump may continually ramp up and down trying to satisfy the snow melt system. For example: A heat exchanger between the boiler loop and the system loop with heavy steel pipe that is slow to transfer heat, has a delay between the time the control signals the pump to add heat to the system and the time the heat can affect the system and be sensed by the control. To prevent oscillations of the pump speed, the “Pump Response” is set to a longer time. In a system with a low mass, dedicated, high input boiler and no heat exchanger, the system responds faster and therefore a shorter time can be set on the “Pump Response” dial. To avoid pump instability, experimentation is usually required; however, most standard installations work well with settings in the 30 to 50 second range.

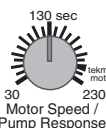

**Motor Speed (mixing valve and 4-20 mA outputs)** - When operating a valve, the control uses the information from the "Motor Speed" dial setting to synchronize various control actions to the valve position and its rate of change. Set this adjustment to match the time required for the actuating motor to drive from the fully closed to the fully open position.

## The 662 Display & Indicator Lights

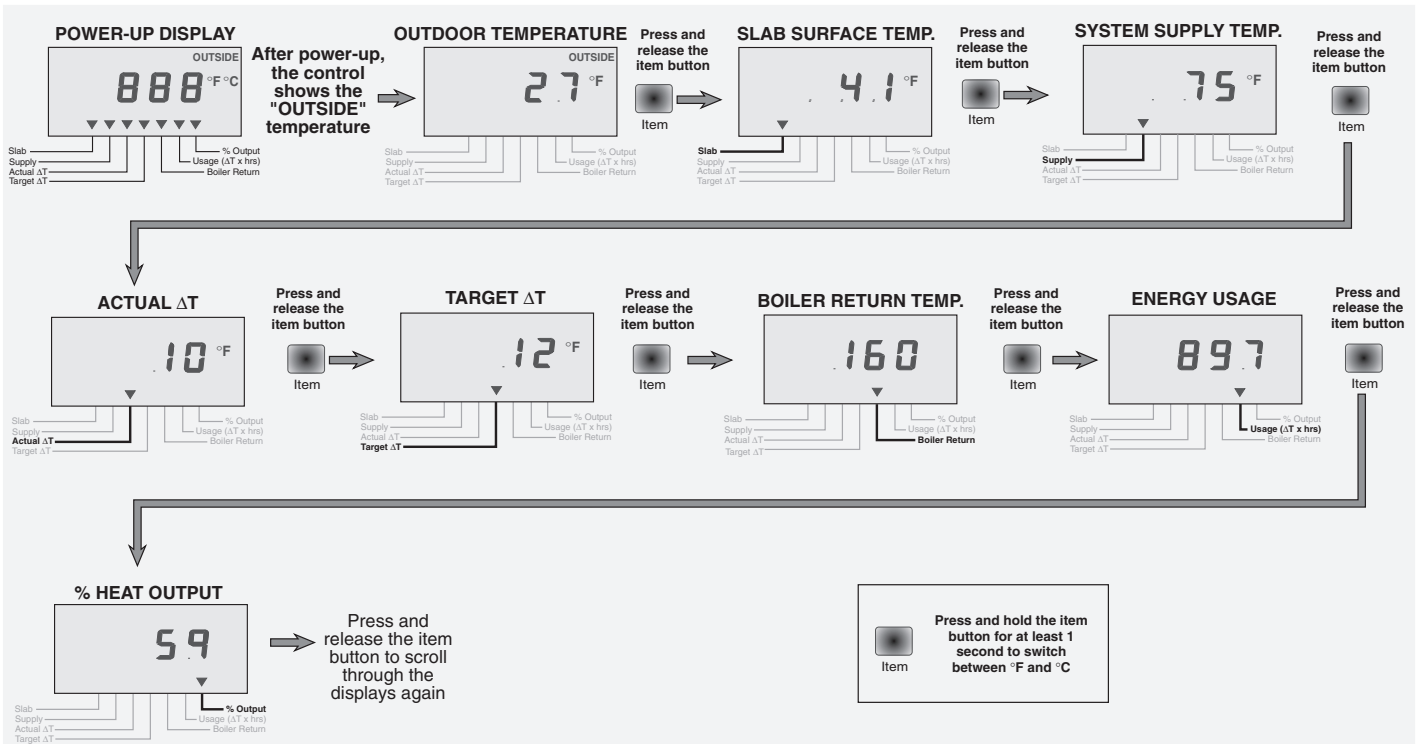

- **Outdoor temperature** is the temperature measured by the Outdoor Sensor 070.
- **Slab Surface temperature** is the temperature of the slab surface as measured by the Snow/Ice Sensor 090. If a Slab Sensor 072 is used, the control provides a best guess for the slab surface temperature when the sensor is placed 1" below the surface.
- **System Supply temperature** is the temperature of the water/glycol solution entering the slab. This temperature may be limited by the control to protect the snow melting system components (see Settings - Max. Supply).
- **Actual ΔT** is the difference between the system supply and return temperatures which gives an indication of the present heat output to the melt system. The Actual ΔT may be limited by the control to protect the slab (see Settings - ΔT Max).
- **Target ΔT** is the ΔT (heat output) that the control is trying to achieve. If the Actual ΔT is below the Target ΔT, the control is trying to increase the heat to the slab. The Actual ΔT may never reach the Target ΔT because the system supply or boiler return temperatures may be limited (see Settings -Max. Supply, Min. Boil. Return).
- **Boiler Return Temperature** is the temperature of the fluid entering the boiler. This sensor reading may cause the control to limit the heat output to the slab in order to protect the boiler (see Settings - Max Boil. Return).
- **Relative Energy Usage (ΔT x hours)**. This display allows the user to estimate the amount of energy used by the snow melt system. The relative energy usage is displayed by alternating between two numbers. When the °C or °F segment is off, the thousands are display . When the °C or °F segment is on, the units are displayed . The energy consumption can be estimated by multiplying the ΔT x hrs by the system flow rate (in US GPM) and by the constant K given in the adjacent table. The accumulated energy usage information can be cleared while the control is in the energy usage display. To do this, press and hold the item button for 1 second and then press the test button.

**Example** -  $\Delta T \times \text{hrs} = 005$  (thousands)  $225$  (units) =  $5225$  °F x hours  
 System flow = 20 US GPM  
 Fluid = 40% glycol & 60% water, therefore  $K = 462$   
 Energy Usage =  $5225 \times 20 \times 462 = 48,279,000$  BTU

K values are calculated averages for most ethylene glycol solutions at 50°F (10°C). K increases with higher temperatures.

% Glycol by weight	Freezing point	K @ 50°F
0%	32°F	500
10%	25°F	496
20%	15°F	487
30%	3°F	477
40%	-13°F	462
50%	-35°F	439

- **% Output** - If a variable speed pump is used, this display indicates the percentage of maximum flow through the pump. If the pump flow rate is 50% of maximum flow, the % Output is 50%. If floating valve action is used, this display indicates the percentage the valve is open. If the valve is half open, the % Output is 50%. If a 4-20 mA device is used, this display indicates the percentage of current output (between 4 and 20 mA) supplied to the device. If the % Output is 50%, the control is delivering 12 mA to the device.

## Indicator lights

Power light on	• The 120 V ac power supply is connected and the control is energized.
Remote light on	• The remote enable input is activated.
WWCO light on	• The control is in Warm Weather Cut Off.
CWCO light on	• The control is in Cold Weather Cut Off.
Melting light on	• The control is in melting mode.
Idling light on	• The control is in idling mode.
Water light on	• The snow/ice sensor is detecting the presence of water.
Maximum $\Delta T$ light	• The control is limiting the temperature drop through the slab to the $\Delta T$ Max setting.
Max. Supply light	• The control is limiting the supply temperature to the Max. Supply setting.
Min. Return light	• The control is operating to keep the boiler return fluid hotter than the Min. Boil. Return setting.
Pump 1 light	• The system pump (P1) relay is on.
Pump 2 light	• The boiler pump (P2) relay is on.
Test light on	• The control is proceeding through the programmed test routine.
Opening light on	• The Open relay is on.
Closing light on	• The Close relay is on.
Boiler light on	• The Boiler relay is on.
Warning light on	• The Warning relay is on.

## Testing the Control Functions

### Step Seven — Operational test of control functions

#### LCD display, indicator lights and Snow/Ice Sensor

When the test button is pressed the red status lights and the LCD segments are turned on for 7 seconds. The current to the Snow/Ice Sensor's internal heater is then increased and if the temperature at the centre of the sensor does not rise at least 2°F within 45 seconds an error message is given. If the centre of the sensor is hotter than 120°F or the outdoor temperature is below -5°F, the control skips this part of the test. During the 45 seconds, the control continues with the rest of the test sequence.

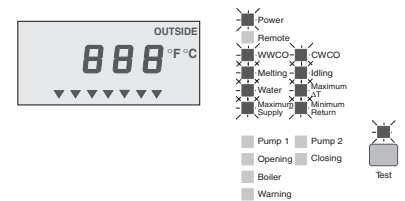

#### Warning on

The Warning relay and light turn on and the LCD shows "W A" to indicate that the external Warning device is being tested. If the warning device does not activate, the wiring from the control should be checked and the warning device examined for possible faults. After 10 seconds, the "Warning" light and relay are turned off and the test continues.



**Note:** The test routine can be halted at this, or any of the following steps, by pushing the Test button once. If this is down, the "Test" light flashes and the control is held in a pause mode for 5 minutes after which time it automatically exits the test routine. Pushing the "Test" button during the 5 minute pause allows the control to resume the test routine at the next step.

#### Melting on

The "Melting" light and relay turn on and the LCD shows "ME" to indicate that the melting device is being tested. If the device connected to the melt relay does not activate, there may be a fault with the wiring to the melting device or with the melting device itself - check both. After 10 seconds, the "Melting" light and relay are turned off and the test continues.



#### Boiler Pump P2 on

The "Pump P2" light and relay turn on and the LCD shows "P 2" to indicate that Pump P2 is being tested. If the pump does not turn on, the wiring to the pump and the pump itself should be checked. This pump remains on through the next part of the test sequence.



#### Boiler Pump P2 on and Boiler on

After Pump P2 has been on for 10 seconds, the "Boiler" light and relay are turned on and the LCD shows "b" to indicate that the boiler is being tested. If the boiler does not turn on, check the wiring to the boiler and the boiler itself. After another 10 seconds, both the boiler and the boiler pump are turned off.



#### Pump P1 on

The Pump P1 relay and light turn on and the LCD shows "P 1" to indicate that Pump P1 is being tested. If the pump does not turn on, check the wiring to the pump and the pump itself. After 10 seconds, the "Pump P1" light and relay turn off and the test continues.



#### Opening on — % Output Increasing

The "Opening" light and relay turn on and the LCD flashes between "OPn" and the current "% Output". The time for the device to go from 0% to 100% is set on the "Motor Speed / Pump Response" dial. During this time, the 4-20 mA, mixing valve or variable speed pump output should increase from 0 to 100 %. If the device does not operate or the output does not increase, check the wiring to the device and the device itself.

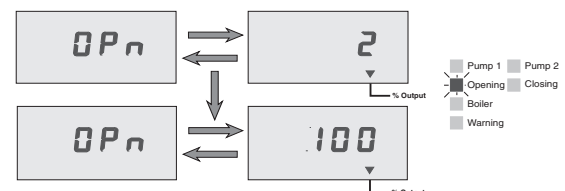

### Closing on — % Output Decreasing

After the Opening relay has turned off, the "Closing" light and relay turn on and the LCD flashes between "CLS" and the current "% Output". The time for the device to go from 100% to 0% is set on the "Motor Speed / Pump Response" dial. During this time, the 4-20 mA, mixing valve or variable speed pump output should decrease from 100 to 0 %.

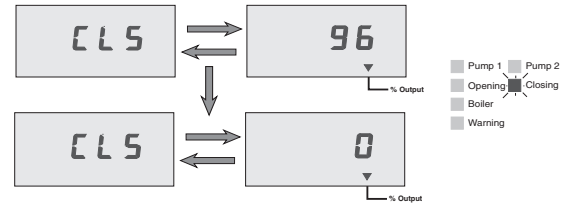

### Step Eight Troubleshooting

First observe the system operating parameters. The source of the problem can often be found by noting a temperature or time reading which seems unreasonable. The indicator lights are also useful in assessing the current state of the control system. Observing what the control is doing, and understanding the sequence of operation greatly aids in isolating the problem. The next step is to press the test button and observe the system components working in sequential order. If a fault in a sensor or its wiring is detected during or after the test sequence, an error message is displayed. The error message look up table provided below can be used to locate the fault. Once the error is identified, refer to Step Five for testing of the wiring and sensors. After any repair has been completed, press the Test button to confirm that correct operation has been restored.

### Step Nine Before you leave

- Make sure wiring dividers are installed in their proper locations between compartments having different voltages.
- Install the wiring cover over the wiring chamber and secure it to the base with the two screws provided. Place the front cover on the control and snap it into place. Install a lock if security is required.
- Place this brochure, and all other brochures relating to the installation, in the protective plastic bag supplied with the control. Place the bag in a conspicuous location near the control for future reference.
- It is important to explain the operation of the control and melting system to all users who may be operating it.

## Error Messages

If a fault occurs during normal operation or during the test routine, the LCD flashes back and forth between the word "Err" and one of the error codes listed.

### OUTDOOR SENSOR – OPEN CIRCUIT

Check the Outdoor Sensor and wiring from the terminal plug to the sensor. When the control has this error, it continues to operate the system assuming an outdoor temperature of 20°F (-6.6°C)

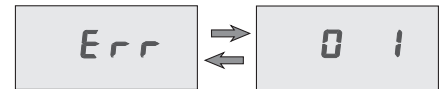

### OUTDOOR SENSOR – SHORT CIRCUIT

Check the Outdoor Sensor and the wiring from the terminal plug to the sensor. When the control has this error, it continues to operate the system assuming an outdoor temperature of 20°F (-6.6°C)

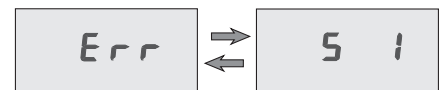

### SUPPLY SENSOR – OPEN CIRCUIT

Check the System Supply Sensor and the wiring from the terminal plug to the sensor. When the control has this error, the melting system is shut down.

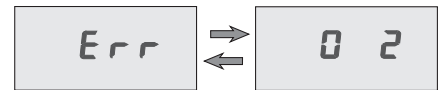

### SUPPLY SENSOR - SHORT CIRCUIT

Check the System Supply Sensor and the wiring from the terminal plug to the sensor. When the control has this error, the melting system is shut down.

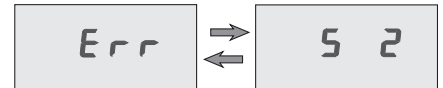

### SYSTEM RETURN SENSOR - OPEN CIRCUIT

Check the System Return Sensor and the wiring from the terminal plug to the sensor. When the control has this error, the melting system is shut down.

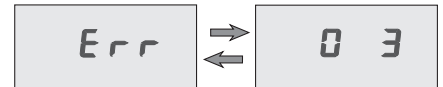

### SYSTEM RETURN SENSOR – SHORT CIRCUIT

Check the System Return Sensor and the wiring from the terminal plug to the sensor. When the control has this error, the melting system is shut down.

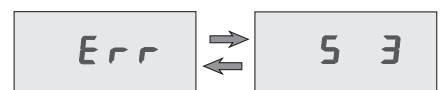

### BOILER RETURN SENSOR – OPEN CIRCUIT

Check the Boiler Return Sensor and the wiring from the terminal plug to the sensor. When the control has this error, the melting system is shut down unless the "Min. Boil Return" dial is turned off.

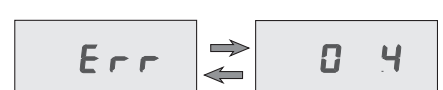

### BOILER RETURN SENSOR – SHORT CIRCUIT

Check the Boiler Return Sensor and the wiring from the terminal plug to the sensor. When the control has this error the melting system is shut down.

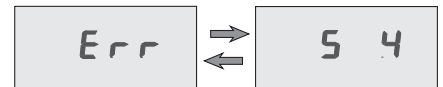

### 090 YELLOW SENSOR – OPEN CIRCUIT

Check the 090 yellow temperature sensor (black and yellow wires, terminals 19 & 21), and the wiring from the terminal plug to the sensor. When the control has this error, the melting system is shut down.

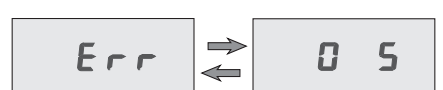

**090 YELLOW SENSOR – SHORT CIRCUIT**

Check the 090 yellow temperature sensor (black and yellow wires, terminals 19 & 21), and the wiring from the terminal plug to the sensor. When the control has this error the melting system is shut down.

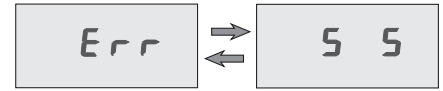

**090 BROWN SENSOR (or SLAB SENSOR 072) – OPEN CIRCUIT**

Check the wiring to the 090 brown temperature sensor (black and brown wires, terminals 19 & 22) or the Slab Sensor 072 (terminals 19 & 22). When the control has this error, the melting system is shut down.

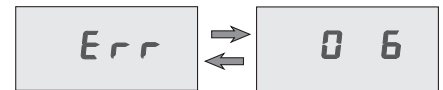

**090 BROWN SENSOR (or SLAB SENSOR 072) – SHORT CIRCUIT**

Check the wiring to the 090 brown temperature sensor (black and brown wires, terminals 19 & 22) or the Slab Sensor 072 (terminals 19 & 22). When the control has this error, the melting system is shut down.

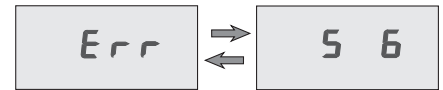

**WATER DETECTION CIRCUIT – OPEN CIRCUIT**

Check the 090 water detection circuit (black and blue wires, terminals 19 & 20) according to brochure D 090. When the control has this error, the melting system can only be operated using a remote enable signal.

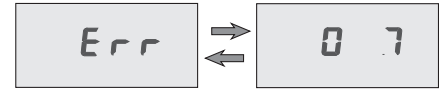

**WATER DETECTION CIRCUIT – SHORT CIRCUIT**

Check the 090 water detection circuit (black and blue wires, terminals 19 & 20) according to brochure D 090. When the control has this error, the melting system can only be operated using a remote enable signal.

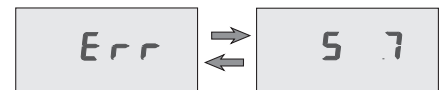

**INTERNAL CONTROL SENSOR – OPEN OR SHORT CIRCUIT**

The control has an internal temperature sensor which monitors the temperature inside the enclosure. If this sensor develops either an open or short circuit, the control continues to operate normally. This sensor is not field repairable.

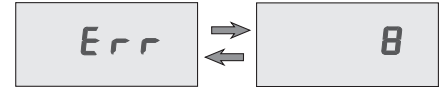

**INTERNAL CONTROL SENSOR – ENCLOSURE OVERHEATED**

This error message is displayed if the enclosure overheats. The 120 V ac variable speed output stops but the 4 - 20 mA and floating outputs are unaffected. Make sure the ambient temperature is less than 104°F (40°C).

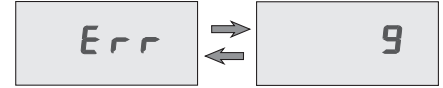

**090 SENSOR – HEATER MALFUNCTION**

Check the 090 heater circuit (red and black wires, terminals 18 & 19) according to brochure D 090. Make sure the yellow and brown wires are not reversed. When the control has this error, the melting system can only be operated using a remote enable signal. If this error persists contact your local tekmar representative.

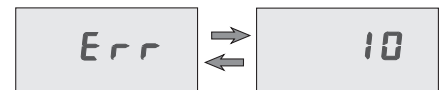

**090 SENSOR - HEATER SHORT CIRCUIT**

If the red and black wires on the 090 Sensor are shorted together, the power supply itself is shorted. When this occurs, the control continuously cycles through the start of the power up routine. This fault should be repaired immediately or damage to the control could result.





# tekmar® - Data Brochure Addendum

Additions to Technical Specifications for type 661

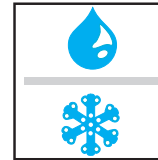

**D 661A**  
09/94

## Snow Detector & Melting Control 661

- Literature — D 661, A 661, D 001, D 090, E 000, E 600  
 Control — Microprocessor PI control; This is **not a safety (limit) control**.  
 Packaged weight — 3.4 lb. (1550 g), Enclosure A, PVC plastic  
 Dimensions — 6-5/8" H x 7-9/16" W x 2-13/16" D (170 x 193 x 72 mm)  
 Approvals — CSA NRTL/C, meets DOC regulations for EMI/RFI.  
 Ambient conditions — Indoor use only, 30 to 105°F (0 to 40°C), < 90% RH non-condensing.  
 Power supply — 120 V ac ±10% 50/60 Hz 20 VA  
 Relays — 120 V ac 10 A 1/3 hp, pilot duty 240 VA 2 A  
 Sensors — NTC thermistor, 10 kΩ @ 25°C ±0.2°C β=3892  
 included: Outdoor Sensor 070.  
 required: Snow/Ice Sensor 090 and Sensor Socket 091. (Order separately)  
 Control accuracy — ±1°F (±0.5°C) with up to 500 feet (150m) of 18 AWG wire to sensors.  
**Detection of Snow/Ice** — **Down to -20°F (-29°C) in calm air with 500 feet (150m) of 18 AWG wire to Snow/Ice Sensor 090.**  
 Surface, Melting — 34 to 44°F (1 to 7°C)  
 Surface, Idling — Off, 24 to 35°F (-5 to 2°C)  
 Water Sensitivity — 20 to 80%  
 Minimum On Time — Off, 0.2 to 4 hours  
 CWCO — Off, -22 to 25°F (-30 to -4°C)

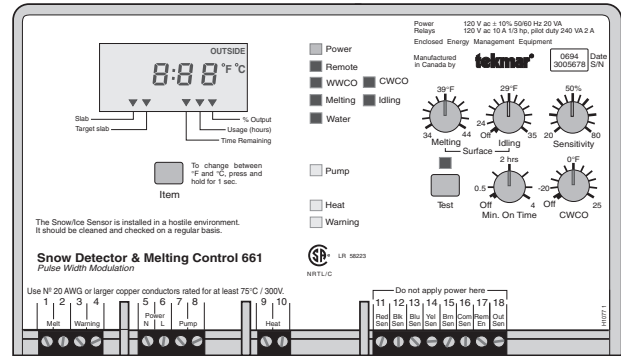

**CAUTION** The nonmetallic enclosure does not provide grounding between conduit connections. Use grounding type bushings and jumper wires.  
**ATTENTION** Un boîtier non métallique n'assure pas la continuité électriques des conduits. Utiliser des manchons ou des fils de accord spécialement conçus pour la mise à la terre.

# tekmar® - Data Brochure Addendum

Additions to Technical Specifications for type 662

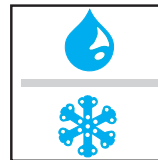

**D 662A**  
09/94

## Snow Detector & Melting Control 662

- Literature — D 662, A 662, D 001, D 090, E 000, E 021, E 600  
 Control — Microprocessor PID control; This is **not a safety (limit) control**.  
 Packaged weight — 4.1 lb. (1900 g), Enclosure A, PVC plastic  
 Dimensions — 6-5/8" H x 7-9/16" W x 2-13/16" D (170 x 193 x 72 mm)  
 Approvals — CSA NRTL/C, meets DOC regulations for EMI/RFI.  
 Ambient conditions — Indoor use only, 30 to 105°F (0 to 40°C), < 90% RH non-condensing.  
 Power supply — 120 V ac ±10% 50/60 Hz 300 VA  
 System Pumps — 120 V ac 6 A 1/3 hp, pilot duty 240 VA 2 A  
 Variable Speed Pump — 120 V ac 50/60 Hz 2.2 A 1/6 hp, internally fused  
 Mix Relays — 24 V ac 10 A, pilot duty 48 VA 2 A  
 Other Relays — 120 V ac 10 A 1/3 hp, pilot duty 240 VA 2 A  
 Sensors — NTC thermistor, 10 kΩ @ 25°C ±0.2°C β=3892  
 included: Outdoor Sensor 070, 3 of Universal Sensor 071, & Slab Sensor 072.  
 optional: Snow/Ice Sensor 090 and Sensor Socket 091.  
 Control accuracy — ±1°F (±0.5°C) with up to 500 feet (150m) of 18 AWG wire.  
**Detection of Snow/Ice** — **Down to -20°F (-29°C) in calm air with 500 feet (150m) of 18 AWG wire to Snow/Ice Sensor 090.**  
 Surface, Melting — 34 to 44°F (1 to 7°C)  
 Surface, Idling — Off, 24 to 35°F (-5 to 2°C)  
 Water Sensitivity — 20 to 80%

- Maximum Supply — 100 to 200°F (38 to 93°C)  
 Min. Boiler Return — Off, 55 to 150°F (13 to 66°C)  
 ΔT max — 10 to 50°F (6 to 28°C)  
 CWCO — Off, -22 to 25°F (-30 to -4°C)  
 Motor Speed — 30 to 230 seconds

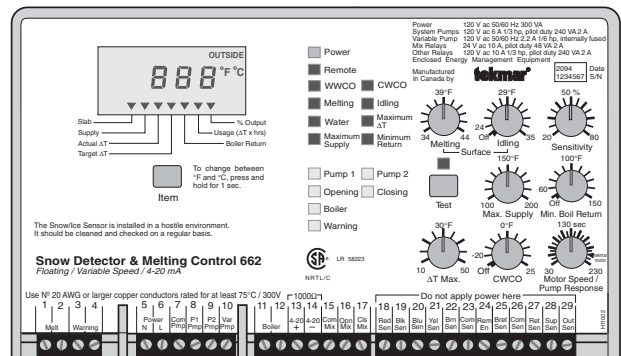

**CAUTION** The nonmetallic enclosure does not provide grounding between conduit connections. Use grounding type bushings and jumper wires.  
**ATTENTION** Un boîtier non métallique n'assure pas la continuité électriques des conduits. Utiliser des manchons ou des fils de accord spécialement conçus pour la mise à la terre.

**In North America:** tekmar Control Systems Ltd., Canada  
 tekmar Control Systems, Inc., USA  
 Head office: 4611 - 23rd Street  
 Vernon, B.C. Canada V1T 4K7  
 Tel. (604) 545-7749 Fax. (604) 545-0650

