

tekmar® - Data Brochure

Snow Detector & Melting Control 661

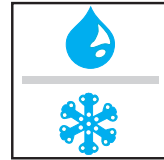

D 661

06/94



The tekmar Snow Detector & Melting Control 661 is a microprocessor-based control which activates a snow/ice melting system based on signals received from a Snow/Ice Sensor 090 and an Outdoor Sensor 070. When the control is in melting mode, the slab is maintained at a "Melting" temperature through an on/off output which operates a contactor for electric cables, a boiler, an injection pump or an injection valve. When the control is not in melting mode, the melt system can either be shut down or it can be maintained at an idle temperature for faster response and improved safety. If a fault occurs in a sensor or its wiring, the control activates a Warning contact.

Sequence of Operation	pg. 2	Testing	pg. 6
Installation	pg. 3	Error Messages	pg. 7
Settings	pg. 5	Technical Data	pg. 8
Display Operation	pg. 6	Limited Warranty	pg. 8

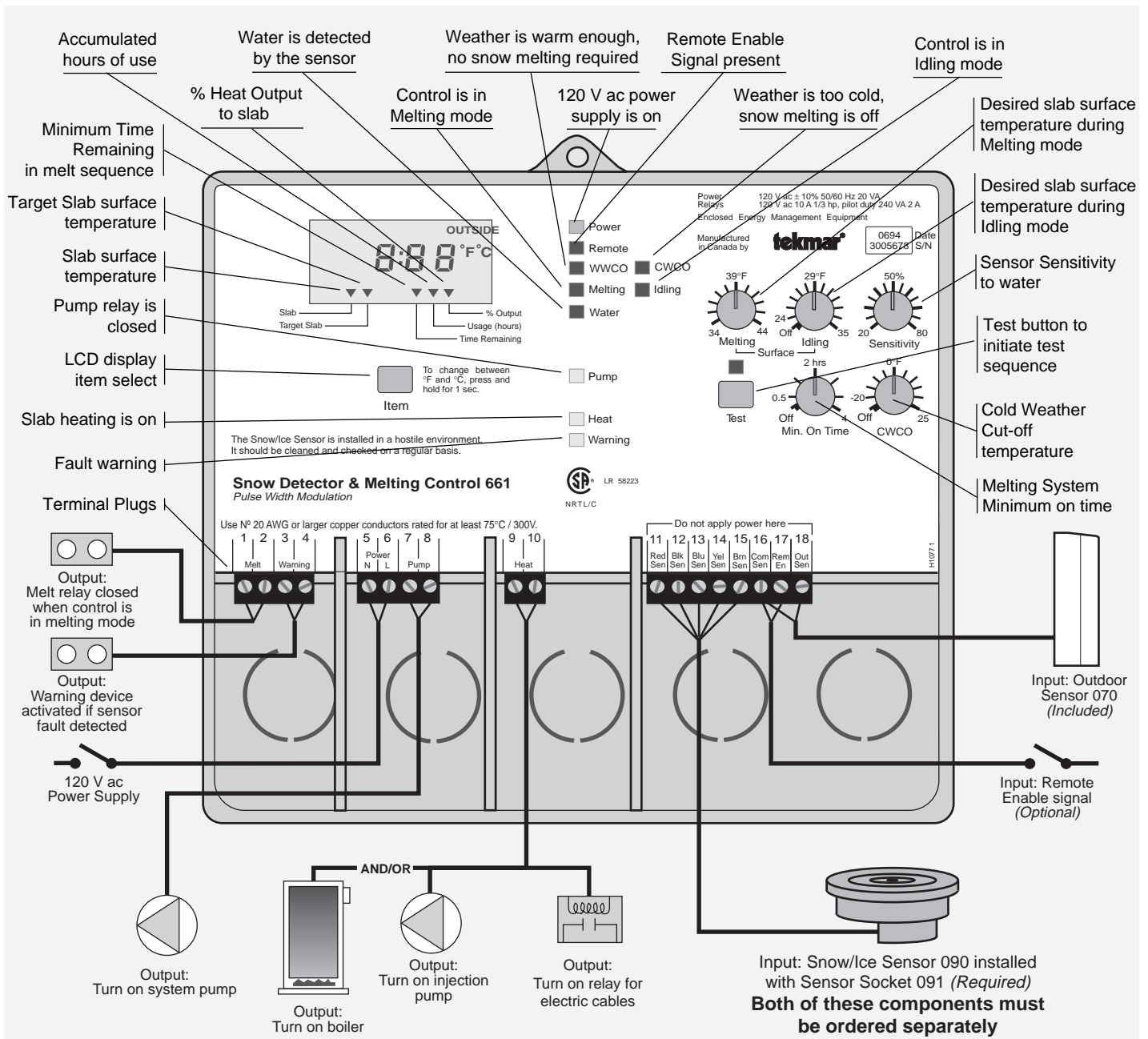

IMPORTANT NOTE:

This control requires a Snow/Ice Sensor 090 and Sensor Socket 091. The Snow/Ice Sensor 090 is usually installed prior to the installation of the control. The installer or designer should plan far enough ahead to allow ample time for ordering and delivery. The Application Brochures A 661 provide a series of schematics which can be used with this control. It is important that these applications together with the sequence of operation provided below are fully understood in order to ensure that the control selected is compatible with its intended use.

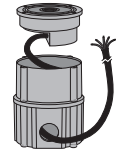

Sequence of Operation

Powering up the control

After the Snow Detector & Melting Control 661 is powered up, the red status lights and the LCD segments are turned on for 7 seconds. The control then displays the "OUTSIDE" temperature.

Melting Mode

Operation using a Snow/ Ice Sensor 090 - The control continually monitors the Snow/Ice Sensor 090.

When snow, ice or water is detected the water light turns on. If the control is not in WWCO or CWCO (see below for an explanation of these terms), melting mode begins.

Operation using a Remote Enable - Melting mode can also be initiated if a remote enable signal is present (terminals Com Sen and Rem Sen shorted together) and the control is not in WWCO or CWCO.

The remote enable is typically used with multiple Snow Melting Controls and Snow/Ice Sensors. It can also be used to manually turn the melting system on by wiring a switch between the remote terminals.

Once the control is in melting mode, the Pump and Melting lights and the Pump and Melt relays are turned on for at least the Minimum On Time set by the Min. On Time dial. The Heat relay is cycled on and off to maintain the slab surface at the "Melting" temperature. The method used to cycle the heat relay is called Pulse Width Modulation (PWM). More information on PWM is provided in Essay 000.

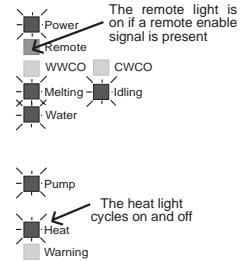

Idling Mode

When the melting system starts from a cold temperature, the time required for the slab to reach "Melting" temperature can be excessive. To decrease this start up time, the slab can be maintained at an "Idling" temperature until melting is required. The Idling feature is also useful for preventing frost and light ice formation. When the control is in idling mode, control operation is similar to melting mode except the "Melting" light is off and the "Idling" light is on.

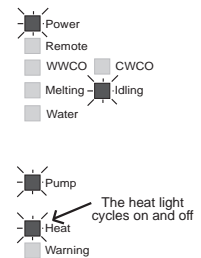

Warm Weather Cut Off (WWCO)

The 661 control can operate with or without an Outdoor Sensor 070. If an outdoor sensor is not used, the control measures the "Outdoor" temperature using the Edge Sensor on the Snow/Ice Sensor 090. If the "Slab" and "Outdoor" temperatures rise above the "Melting" temperature, the control shuts down the melting system and enters Warm Weather Cut Off mode. The control remains in WWCO until the "Outdoor" temperature drops below the "Melting" temperature. The control then continues with normal operation.

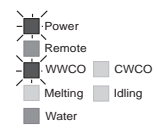

Cold Weather Cut Off (CWCO)

Maintaining the slab at a "Melting" or "Idling" temperature in extremely cold weather can be expensive and may even be impossible. When it does snow at these colder temperatures, the snow is usually dry, light and less slippery. The control therefore turns the melting system off when the "Outdoor" temperature (measured using either the Outdoor Sensor 070 or the 090 Edge Sensor) drops below the "CWCO" setting. The heater in the Snow/Ice Sensor 090 is kept on during CWCO until the control detects snow. If snow is detected, the heater is turned off but the control retains the snow detected information. When the "Outdoor" temperature rises above the "CWCO" temperature, the control exits CWCO and continues with normal operation.

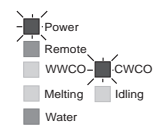

Warning Light and Relay

If a sensor fault occurs, the warning relay and light are turned on and an error message is given. The lookup table provided on page 7 can be used to determine which sensor has the fault.



Exercising the pump

To prevent the pump from seizing during long WWCO periods, the Pump relay is turned on for 20 seconds after every 3 days of no operation. During exercising, the LCD screen alternates between two special characters as illustrated in the diagram.

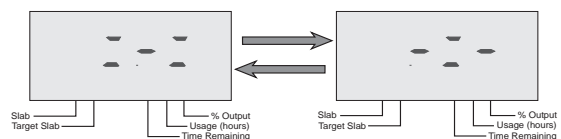

Installation

Caution

Improper installation and operation of this control could result in damage to the equipment and possibly even personal injury. It is your responsibility to ensure that this control is safely installed according to all applicable codes and standards. This electronic control is not intended for use as a primary limit control. Other controls that are intended and certified as safety limits must be placed into the control circuit.

Step One Getting ready

Check the contents of this package. If any of the contents listed are missing or damaged, please refer to the Limited Warranty and Product Return Procedure on the back of this brochure and contact your wholesaler or tekmar sales agent for assistance.

Type 661 includes:

- One Snow Detector & Melting Control 661
- One Outdoor Sensor 070
- One Data Brochure D 661
- Application Brochures A 661
- One Data Brochure D 001

Other information available:

- Essay E 000
- Essay E 600

Read Application Brochures A 661 and select the correct Application for your job.

Note : This control must be installed with a Snow/Ice Sensor 090 and Socket 091. The Snow/Ice Sensor 090 and Socket 091 are not included with the type 661 and must be ordered separately.

Carefully read the details of the Sequence of Operation sections in all applicable brochures to ensure that you have chosen the proper control and you understand its functions within the operational requirements of your system.

Step Two Mounting of the base

The control should be removed from its base by pressing down on the release clip in the wiring chamber and sliding upwards on the control. The base is then mounted in accordance with the instructions in the Data Brochure D 001.

Step Three Rough-in Wiring

All electrical wiring terminates in the control base wiring chamber. It has standard 7/8" (22mm) knock-outs that accept common wiring hardware and conduit fittings. Before breaking out the knock-outs, check the wiring diagram and select those sections of the chamber with common voltages. Do not allow the wiring to cross over sections as safety dividers, installed later, prevent this.

Power should not be applied to any of the wires during the rough-in wiring stage.

- Install the Snow/Ice Sensor 090 according to the instructions in Data Brochure D 090 and run the wiring back to the base.
- Run the wiring from other system components to the base.
- Run the wiring from the 120 V ac source to the base. Use a clean 120 V ac power source to ensure proper operation.
- Multi-strand 16 AWG wire is recommended for the 120 V ac wiring due to its superior flexibility and ease of installation into the terminal sockets.

Step Four Electrical connection to the control

Power and output connections

- **The installer should test to confirm that no voltage is present at any of the wires.**
- Install the control back into the base, sliding it down until it snaps into place.
- Connect the 120 V ac power supply to terminals *Power N* — *Power L* (5 and 6).

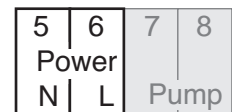

Melt Output

- Connect the melting system circuit to terminals *Melt* (1 and 2). These terminals lead to an unpowered (dry) relay contact inside the control which closes when the control is in melting mode. The most common devices to be turned on (enabled) by the 661 are pumps, heating devices or other tekmar controls.



Warning Output

- If desired, connect a warning device to terminals *Warning* (3 and 4). These terminals lead to a dry relay contact inside the control which closes when there is a sensor or wiring failure.

Caution: The 661 is an operating control and is not certified as a safety device. If safety considerations are critical, a separate alarm system must be installed.



Pump Output

- Connect the System Pump to terminals *Pump* (7 and 8). These terminals lead to a dry relay contact which closes when the control is in melting mode or idling mode.

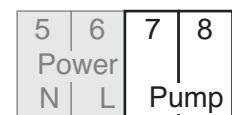

Heat Output

- Connect the heating device circuit (electric cables, injection pump, injection valve, or boiler) to terminals *Heat* (9 and 10). These terminals lead to a dry relay contact which closes when the control requires heat to be added to the slab.

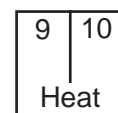

Sensor and unpowered input connections

Power should never be applied to these terminals. Damage to the control will result.

Snow/Ice Sensor 090 (Must be ordered separately)

This control is designed for use with the tekmar Snow/Ice Sensor 090. *The sensor must be installed flush with the slab surface and 1/2 way between the cables or heating pipes.* See Data Brochure D 090 for the installation instructions regarding the Snow/Ice Sensor 090 and Socket 091.

- Connect the red wire from the sensor cable to terminal *Red Sen* (11).
- Connect the black wire from the sensor cable to terminal *Blk Sen* (12).
- Connect the blue wire from the sensor cable to terminal *Blu Sen* (13).
- Connect the yellow wire from the sensor cable to terminal *Yel Sen* (14).
- Connect the brown wire from the sensor cable to terminal *Brn Sen* (15).

11	12	13	14	15	16	17	18
Red Sen	Blk Sen	Blu Sen	Yel Sen	Brn Sen	Com Sen	Rem En	Out Sen

Outdoor Sensor

- Connect the two wires from the Outdoor Sensor 070 to the terminals *Com Sen* — *Out Sen* (16 and 18).

11	12	13	14	15	16	17	18
Red Sen	Blk Sen	Blu Sen	Yel Sen	Brn Sen	Com Sen	Rem En	Out Sen

Remote Enable (Optional)

- If an external remote enable device is used, connect the two device wires to terminals *Rem En* — *Com Sen* (16 and 17). When these terminal are shorted together, the control registers a remote enable.

11	12	13	14	15	16	17	18
Red Sen	Blk Sen	Blu Sen	Yel Sen	Brn Sen	Com Sen	Rem En	Out Sen

Electrical connections to terminal plugs of control 661. Control relays are shown in the "power down" condition.

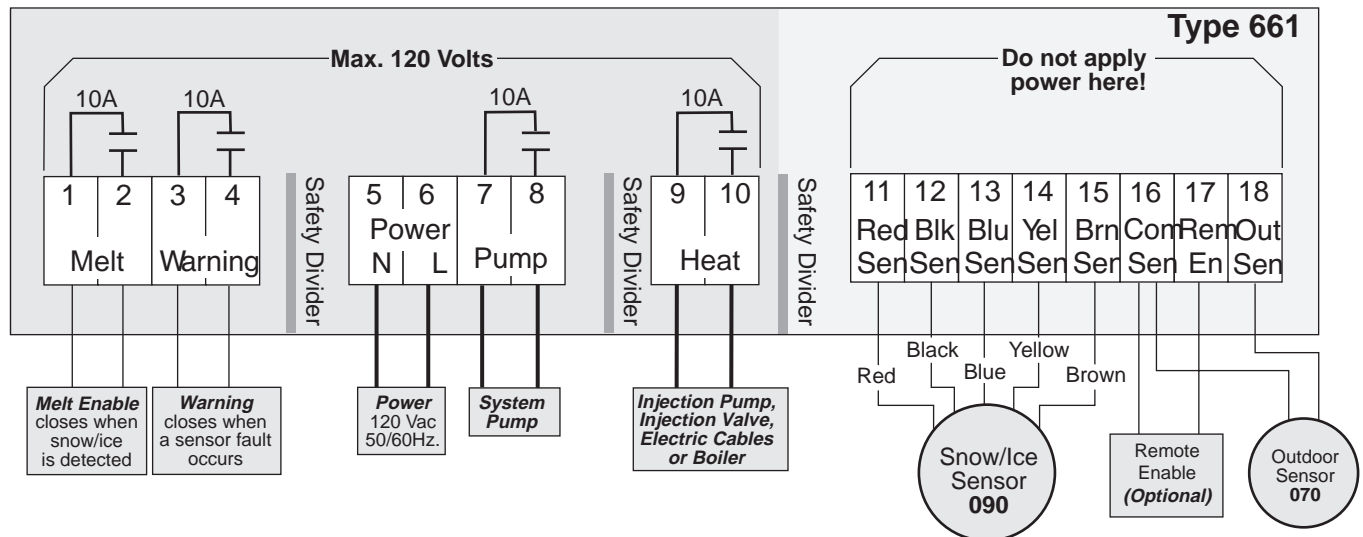

Note: This is not a wiring diagram. For detailed wiring schematics, refer to the Application Brochures A 661.

Step Five Testing the wiring

- Before applying power to the control for testing, each terminal plug must be unplugged from the control header. Pull straight down to unplug.
- These tests are to be performed using standard testing practices and procedures and should only be carried out by properly trained and experienced persons.
- A good quality electrical test meter, capable of reading from at least 0 — 200 Volts ac, and at least 0 — 2,000,000 Ohms, is essential to properly test this control.

Test the sensors

- In order to test the sensors, the actual temperature at each sensor must be known. A good quality digital thermometer with a surface temperature probe is recommended for ease of use and accuracy of testing. Where a thermometer is not available, a spare sensor can be strapped alongside the one to be tested and the readings compared. Test the outdoor sensor and the Snow/Ice sensor according to the instructions in brochures D 001 and D 090.

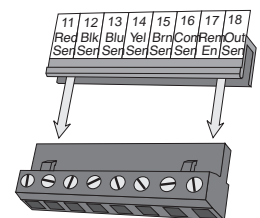

Disconnect terminal plug from its header

Test the power supply

- Make sure exposed wiring or terminals are not grounded or in contact with other wires. Turn on the 120 V ac power and, using an AC voltmeter, you should measure between 110 and 130 V ac at the *Power N – L* (5 and 6) terminals.

Test the Outputs

- If a device is connected to the *Melt* terminals (1 and 2), make sure power to the device is off and install a jumper between terminals 1 and 2. When the device is powered-up, it should operate. If it does not turn on, check the wiring from the terminal plug to the device and refer to any installation or troubleshooting information supplied with the device. If the device is operating properly, disconnect the power and remove the jumper.
- Repeat this procedure for any devices connected to the *Warning* terminals (3 and 4), *Pump* terminals (7 and 8) and *Heat* terminals (9 and 10).

Connect the control

- **Turn the power off and make sure all test jumpers have been removed from the plugs.**
- Connect the plugs to the control by carefully aligning them with their respective headers and pushing them upwards. The plugs should snap firmly into the headers.
- Install the supplied safety dividers between the different voltage wiring chambers. Apply power to the control.
- The control is now ready for operation.

Settings

Step Six Essential control settings

Before adjusting the dial settings, read through the sequence of operation to ensure that you understand how the control operates. The dials are factory set at the midpoint of each setting. This reflects typical settings for most systems and is therefore a good starting point.

Melting Surface Temperature

The “Melting” dial setting is the desired slab surface temperature when the control is in melting mode and is also used as the WWCO temperature. The “Melting” temperature is usually set based on local weather conditions. In some areas, heavy snow fall can load a slab at temperatures well above freezing; in these areas the dial should be set higher. If the melting system response is sluggish, increasing the “Melting” dial setting may cause the system to melt faster, however, it is important to remember that increasing this setting generally increases energy consumption.

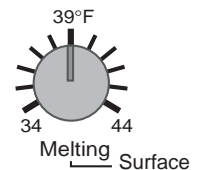

Idling Surface Temperature

The “Idling” dial setting is based on the requirements of the user. If minimizing the time required for the slab to reach melting temperature is important then the dial is set slightly below freezing (<32°F). If black ice or frost formation is a concern, the dial is set slightly above freezing (>32°F). It is important to remember that increasing this dial setting increases energy consumption. “Idling” can also be set to “Off”.

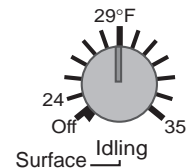

Water detection sensitivity

The sensitivity of the Snow/Ice Sensor to water can be adjusted using the “Sensitivity” dial. As snow becomes contaminated with dirt, and as the sensor surface itself becomes dirty, the control may incorrectly indicate the presence of water. If this condition occurs, clean the surface of the sensor and/or turn down the sensitivity setting. If the snow and rain in the area is very clean, the sensitivity setting may need to be increased before snow is detected.

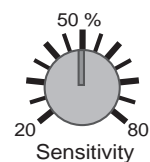

Note: The Snow/Ice Sensor is installed in a hostile environment and should be cleaned on a regular basis with a wire brush. After cleaning, check operation by pressing the test button to cycle the control through the test routine.

CWCO (Cold Weather Cut Off)

The “CWCO” temperature is the coldest temperature at which the melting system operates. This dial is set based on the melting capabilities of the snow melt system and the economics of melting snow in extreme conditions.

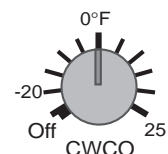

Minimum On Time

The Minimum On Time setting is primarily used to ensure a minimum operating time regardless of the Snow/Ice Sensor reading. The built in timer starts counting down once the slab has reached the “Melting” temperature. If water is detected after the Minimum On Time has elapsed, the control continues in melting mode until water is no longer detected by the Snow/Ice Sensor.

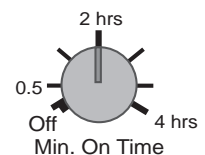

Display and Indicator Lights Operation

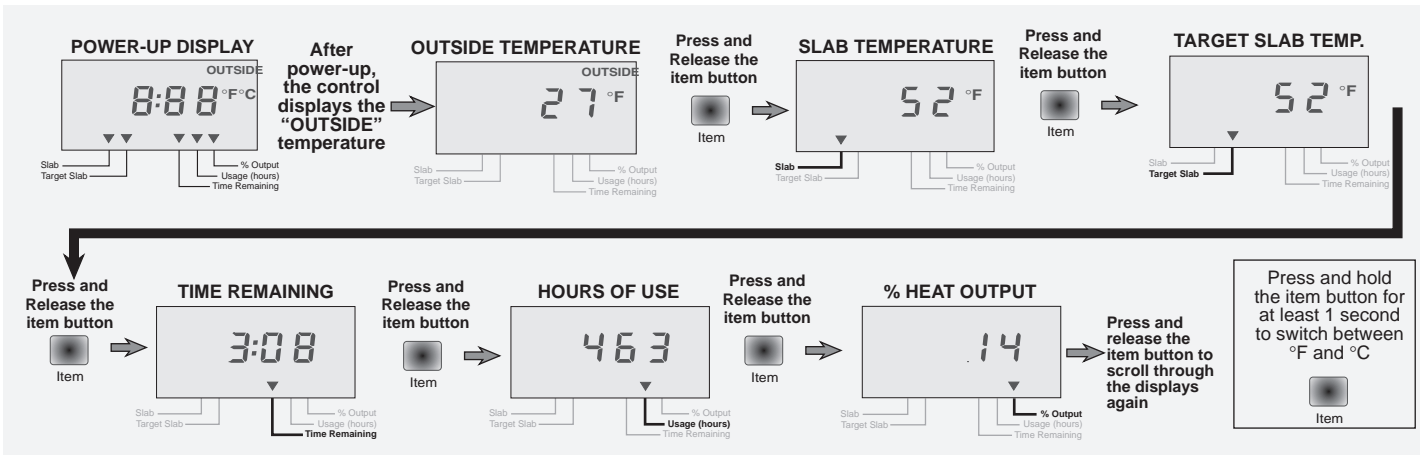

- **Slab** - This is the present surface temperature of the slab as measure by the Snow/Ice Sensor.
- **Target Slab** - This is the temperature the control wants to achieve i.e. the "Melting" or "Idling" dial setting.
- **Time Remaining** - When the control is in melting mode and the slab has reached the temperature set by the "Melting" dial, a timer starts. This display indicates the hours and minutes remaining until the Minimum On Time is reached. The melting system continues operating after the Minimum On Time is reached if water is still detected.
- **Usage** - The control displays the total number of hours the heat relay has been on. The upper three digits of the number are displayed first followed by the lower three digits, followed by a pause.
Example: the control flashes 001 then 298 then pause. The hours of use are therefore 001,298
- **% Output** - The control varies the amount of heat applied to the snow melt system by cycling the heat relay on and off. This display indicates the percentage of time the heat relay is on.

Indicator lights

- | | | |
|-------------------------|---|---|
| <i>Power light on</i> | • | The 120 V ac power supply is connected and the control energized. |
| <i>Remote light on</i> | • | The remote enable input is activated. |
| <i>WWCO light on</i> | • | The control is in Warm Weather Cut Off. |
| <i>CWCO light on</i> | • | The control is in Cold Weather Cut Off. |
| <i>Melting light on</i> | • | The system is in Melting Mode. |
| <i>Idling light on</i> | • | The system is in Idling Mode. |
| <i>Water light on</i> | • | The Snow/Ice Sensor 090 is detecting the presence of water. |
| <i>Pump light on</i> | • | The Pump relay is on. |
| <i>Heat light on</i> | • | The Heat relay is on. |
| <i>Test light on</i> | • | The control is proceeding through the programmed test routine. |
| <i>Warning light on</i> | • | The Warning relay is on. |

Testing the Control Functions

Step Seven — Operational test of control functions

LCD display, indicator lights and Snow/Ice Sensor

When the test button is pressed, the red status lights and LCD segments are turned on for 7 seconds. The current to the Snow/Ice Sensor's internal heater is then increased and if the temperature at the centre of the sensor does not rise at least 2°F in 42 seconds, a warning and error message is given. If the centre of the sensor is hotter than 120°F or the outdoor temperature is below -5°F, the control skips this part of the test. During the 42 seconds the control continues with the remainder of the test sequence.

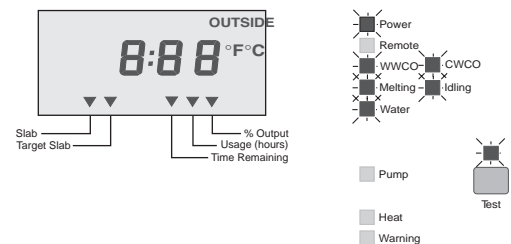

Warning on

The Warning relay and light turn on and the LCD shows "W A" to indicate that the Warning device is being tested. If the external warning device does not activate, the wiring from the control should be checked and the warning device examined for possible faults. After 10 seconds, the Warning light and relay are turned off and the test continues.



Note: The test routine can be halted at this, or any of the following steps, by pushing the Test button once. If this is done, the "Test" light flashes and the control is held in a pause mode for 5 minutes after which time it automatically exits the test routine. Pushing the Test button during the 5 minute pause allows the control to resume the test routine at the next step.

Melting on

The Melting relay and light turn on and the LCD shows "ME" to indicate that the melting device is being tested. If the melting device does not activate, there may be a fault with the wiring or with the melting device itself - check both. After 10 seconds, the Melting light and relay are turned off and the test continues.

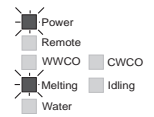

Heat on

The Heat relay and light turn on and the LCD shows "HE" to indicate that the heating device is being tested. If the heating device does not activate, both the wiring and the heating device should be checked. After 10 seconds, the Heat light and relay are turned off and the test continues.



Pump on

The Pump relay and light turn on and the LCD shows "P 1" to indicate that the pump is being tested. If the pump does not activate, the wiring from the control should be checked and the pump examined. After 10 seconds, the pump light and relay are turned off and the control exits the test sequence.



Step Eight Troubleshooting

First observe the system operating parameters. The source of the problem can often be identified by noting a temperature or time reading which seems unreasonable. The indicator lights are also useful to in assessing the current state of the control system. Observing what the control is doing, and understanding the sequence of operation greatly aids in isolating the problem. The next step is to push the test button and observe the system components working in a sequential order. If a sensor fault is found during or after the test sequence, an error message is displayed. The error message look up table provided below can be used to determine which sensor circuit has the fault. Once the error is located, refer to Step Five for testing of the wiring and sensors. After any repair has been completed, press the Test button to confirm that correct operation has been restored.

Step Nine Before you leave

- Make sure wiring dividers are installed in their proper locations between the compartments that have different voltages.
- Install the wiring cover over the wiring chamber and secure it to the base with the two screws provided. Place the front cover on the control and snap into place. Install a lock if security is required.
- Place this brochure, and all other brochures relating to the installation, in the protective plastic bag supplied with the control. Place the bag in a conspicuous location near the control for future reference.
- It is important to explain the operation of the control and melting system to all users who may be operating it.

Error Messages

Outdoor Sensor - Open Circuit

Check the Outdoor Sensor and wiring from the terminal. When the control has this error, it continues operation using only the Snow/Ice Sensor.

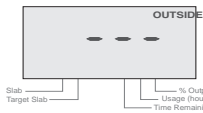

Outdoor Sensor - Short Circuit

Check the Outdoor Sensor and wiring from the terminal. When the control has this error, it continues operation using only the Snow/Ice Sensor.

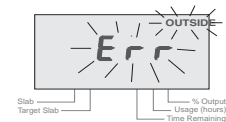

090 Centre Sensor Failure

Check the 090 center temperature sensor and the wiring to the sensor (black and yellow wires, terminals 12 & 14). When the control has this error, the melting system is shut down.

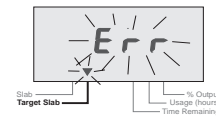

090 Edge Sensor Failure

Check the 090 edge temperature sensor and the wiring to the sensor (black and brown wires, terminals 12 & 15). When the control has this error, the melting system is shut down.

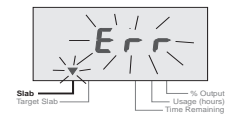

090 Heater Failure

Check the 090 heater circuit (red and black wires, terminals 11 & 12). This error can result from a red wire open circuit or a reversal of the yellow and brown wires. When the control has this error, the melting system can only be operated using a remote enable signal.



090 Water Detector Failure

Check the 090 water circuit (black and blue wires, terminals 12 & 13). When the control has this error, the system can only be operated using a remote enable signal.

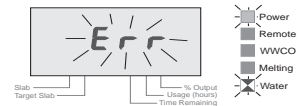

090 Heater Shorted

If the red and black wires on the 090 Sensor are shorted together, the power supply itself is shorted. When this occurs, the control continuously cycles through the start of the power up routine. This fault should be repaired immediately or damage to the control could result.

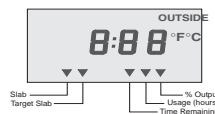

Technical Data

Snow Detector & Melting Control 661

Literature	— D 661, A 661, D 001, D 090, E 000, E 600
Control	— Microprocessor PI control; This is not a safety (limit) control .
Packaged weight	— 3.4 lb. (1550 g), Enclosure A, PVC plastic
Dimensions	— 6-5/8" H x 7-9/16" W x 2-13/16" D (170 x 193 x 72 mm)
Approvals	— CSA NRTL/C, meets DOC regulations for EMI/RFI.
Ambient conditions	— Indoor use only, 30 to 105°F (0 to 40°C), < 90% RH non-condensing.
Power supply	— 120 V ac ±10% 50/60 Hz 20 VA
Relays	— 120 V ac 10 A 1/3 hp, pilot duty 240 VA 2 A
Sensors	— NTC thermistor, 10 kΩ @ 25°C ±0.2°C β=3892
included:	Outdoor Sensor 070.
required:	Snow/Ice Sensor 090 and Sensor Socket 091. (Order separately)
Control accuracy	— ±1°F (±0.5°C) with up to 500 feet (150m) of 18 AWG wire to sensors.
Surface, Melting	— 34 to 44°F (1 to 7°C)
Surface, Idling	— Off, 24 to 35°F (-5 to 2°C)
Water Sensitivity	— 20 to 80%
Minimum On Time	— Off, 0.2 to 4 hours
CWCO	— Off, -22 to 25°F (-30 to -4°C)

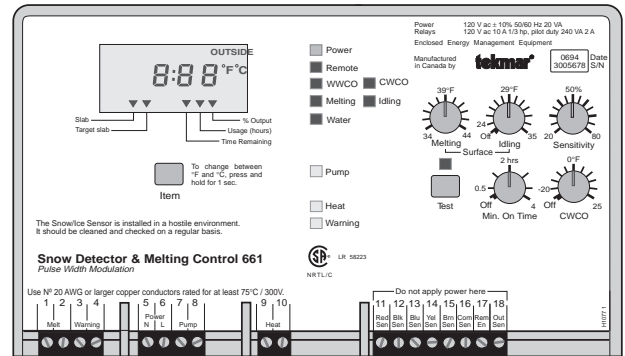

The installer must ensure that this control and its wiring are shielded from strong sources of electromagnetic noise. Conversely, this electronic control does not exceed Class B limits for radio noise emissions from digital apparatus as set out in the Radio Interference Regulations of the Canadian Department of Communications. If this equipment does cause interference, the user is encouraged to try to correct the interference by reorientating the receiving antenna and/or relocating the receiver with respect to this equipment. Le présent numérique n'émette pas de bruits radioélectriques dépassant les limites applicables aux appareils numériques de Classe B prescrites dans le règlement sur le brouillage radioélectrique édicté par le Ministère des Communications du Canada.

Limited Warranty and Product Return Procedure

Limited Warranty: tekmar warrants to the original purchaser each tekmar product against defects in workmanship and materials when the product is installed and used in compliance with tekmar's instructions. This limited warranty covers the cost of parts and labour provided by tekmar to correct defects in materials and/or workmanship. Returned products that are fully operational are not considered a warranty case. tekmar also does not cover parts or labour to remove, transport or reinstall a defective product. tekmar will not be liable for any damage other than repair or replacement of the defective part or parts and such repair or replacement shall be deemed to be the sole remedy from tekmar. This warranty shall not apply to any defects caused or repairs required as a result of unreasonable or negligent use, neglect, accident, improper installation, or unauthorised repair or alterations. In case of defect, malfunction or failure to conform to warranty, tekmar will, for a warranty period of 24 months from the date of invoice to the original purchaser or 12 months from the date of installation of the product, whichever occurs first, repair, exchange or give credit for the defective product. Any express or implied warranty which the purchaser may have, including merchantability and fitness for a particular purpose, shall not extend beyond 24 months from the date of invoice or 12 months from the date of installation of the product, whichever occurs first.

Replacements: tekmar can send replacement products if requested. All replacements are invoiced. Any possible credit for the replacement will only be issued once the replaced product has been returned to tekmar.

Product Return Procedure: Products that are believed to have failed must be returned to tekmar Control Systems Ltd. 4611-23rd Street, Vernon B.C. Canada V1T 4K7 when agreed to by tekmar. The installer or other qualified service person must, at the owners expense, determine which component has failed. The product must be returned complete with all of its components (sensors, base, etc.). Products must be returned together with the proof of

purchase to the original purchaser who then returns the product to tekmar after receiving a Return Goods Authorisation (RGA) number from tekmar.

Please include the following information with the product: The full address of the original purchaser, the RGA number and a description of the problem.

From the U.S.A., in order to avoid customs charges, products must be returned via US Post with the package clearly marked with the RGA number, product type and the statement "Canadian Product returned for repair". For shipping purposes the product can be valued at one half list price.

- 1) If returned during the warranty period and the product is defective, tekmar will issue full credit for the returned product less cost of missing parts.
- 2) If returned during the warranty period and the product is fully operational, tekmar will return the product to the original purchaser for a testing cost of \$30.00 plus postage.
- 3) If returned during the warranty period and the product is not damaged and is fully operational, tekmar can take back the product for a return charge of 40% of the product's net value. This request has to be specified otherwise the product will be returned with a testing cost of \$30.00 plus postage.
- 4) If returned after the warranty period and the product needs repair, tekmar will repair and return the product. Repair and postage costs will be invoiced. tekmar's repair costs are calculated at \$30.00 / hour plus the cost of parts. If the repair costs will be more than \$60.00 a repair estimate will be sent to the original purchaser.

In North America:	tekmar Control Systems Ltd., Canada tekmar Control Systems, Inc., USA Head office: 4611 - 23rd Street Vernon, B.C. Canada V1T 4K7 Tel. (604) 545-7749 Fax. (604) 545-0650
--------------------------	---



tekmar® - Data Brochure Addendum

Additions to Technical Specifications for type 661

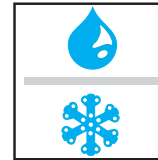

D 661A
09/94

Snow Detector & Melting Control 661

- Literature — D 661, A 661, D 001, D 090, E 000, E 600
 Control — Microprocessor PI control; This is **not a safety (limit) control**.
 Packaged weight — 3.4 lb. (1550 g), Enclosure A, PVC plastic
 Dimensions — 6-5/8" H x 7-9/16" W x 2-13/16" D (170 x 193 x 72 mm)
 Approvals — CSA NRTL/C, meets DOC regulations for EMI/RFI.
 Ambient conditions — Indoor use only, 30 to 105°F (0 to 40°C), < 90% RH non-condensing.
 Power supply — 120 V ac ±10% 50/60 Hz 20 VA
 Relays — 120 V ac 10 A 1/3 hp, pilot duty 240 VA 2 A
 Sensors — NTC thermistor, 10 kΩ @ 25°C ±0.2°C β=3892
 included: Outdoor Sensor 070.
 required: Snow/Ice Sensor 090 and Sensor Socket 091. (Order separately)
 Control accuracy — ±1°F (±0.5°C) with up to 500 feet (150m) of 18 AWG wire to sensors.
Detection of Snow/Ice — **Down to -20°F (-29°C) in calm air with 500 feet (150m) of 18 AWG wire to Snow/Ice Sensor 090.**
 Surface, Melting — 34 to 44°F (1 to 7°C)
 Surface, Idling — Off, 24 to 35°F (-5 to 2°C)
 Water Sensitivity — 20 to 80%
 Minimum On Time — Off, 0.2 to 4 hours
 CWCO — Off, -22 to 25°F (-30 to -4°C)

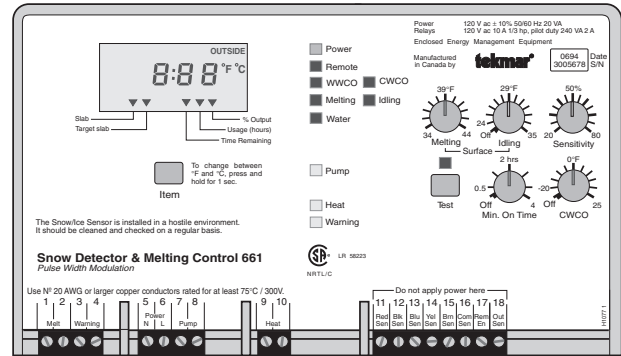

CAUTION The nonmetallic enclosure does not provide grounding between conduit connections. Use grounding type bushings and jumper wires.
ATTENTION Un boîtier non métallique n'assure pas la continuité électriques des conduits. Utiliser des manchons ou des fils de accord spécialement conçus pour la mise à la terre.

tekmar® - Data Brochure Addendum

Additions to Technical Specifications for type 662

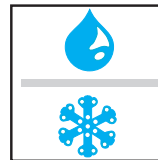

D 662A
09/94

Snow Detector & Melting Control 662

- Literature — D 662, A 662, D 001, D 090, E 000, E 021, E 600
 Control — Microprocessor PID control; This is **not a safety (limit) control**.
 Packaged weight — 4.1 lb. (1900 g), Enclosure A, PVC plastic
 Dimensions — 6-5/8" H x 7-9/16" W x 2-13/16" D (170 x 193 x 72 mm)
 Approvals — CSA NRTL/C, meets DOC regulations for EMI/RFI.
 Ambient conditions — Indoor use only, 30 to 105°F (0 to 40°C), < 90% RH non-condensing.
 Power supply — 120 V ac ±10% 50/60 Hz 300 VA
 System Pumps — 120 V ac 6 A 1/3 hp, pilot duty 240 VA 2 A
 Variable Speed Pump — 120 V ac 50/60 Hz 2.2 A 1/6 hp, internally fused
 Mix Relays — 24 V ac 10 A, pilot duty 48 VA 2 A
 Other Relays — 120 V ac 10 A 1/3 hp, pilot duty 240 VA 2 A
 Sensors — NTC thermistor, 10 kΩ @ 25°C ±0.2°C β=3892
 included: Outdoor Sensor 070, 3 of Universal Sensor 071, & Slab Sensor 072.
 optional: Snow/Ice Sensor 090 and Sensor Socket 091.
 Control accuracy — ±1°F (±0.5°C) with up to 500 feet (150m) of 18 AWG wire.
Detection of Snow/Ice — **Down to -20°F (-29°C) in calm air with 500 feet (150m) of 18 AWG wire to Snow/Ice Sensor 090.**
 Surface, Melting — 34 to 44°F (1 to 7°C)
 Surface, Idling — Off, 24 to 35°F (-5 to 2°C)
 Water Sensitivity — 20 to 80%

- Maximum Supply — 100 to 200°F (38 to 93°C)
 Min. Boiler Return — Off, 55 to 150°F (13 to 66°C)
 ΔT max — 10 to 50°F (6 to 28°C)
 CWCO — Off, -22 to 25°F (-30 to -4°C)
 Motor Speed — 30 to 230 seconds

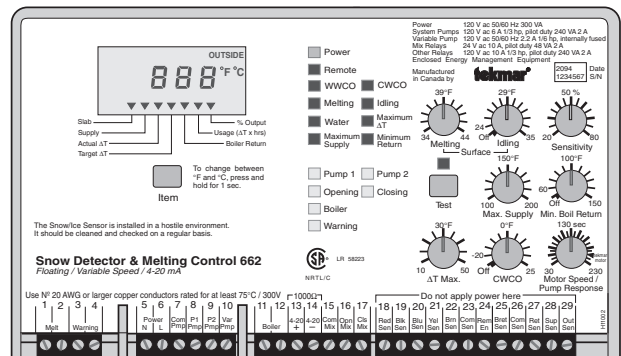

CAUTION The nonmetallic enclosure does not provide grounding between conduit connections. Use grounding type bushings and jumper wires.
ATTENTION Un boîtier non métallique n'assure pas la continuité électriques des conduits. Utiliser des manchons ou des fils de accord spécialement conçus pour la mise à la terre.

In North America: tekmar Control Systems Ltd., Canada
 tekmar Control Systems, Inc., USA
 Head office: 4611 - 23rd Street
 Vernon, B.C. Canada V1T 4K7
 Tel. (604) 545-7749 Fax. (604) 545-0650

