

The tekmar® Two-Stage Boiler Control type 220 regulates the supply water temperature of two boilers as a function of the outdoor (and optionally indoor) air temperatures. The control initially regulates the supply water temperature by varying the duty cycle (on time versus off time) of the first boiler. When the first boiler is operating continually, but the supply water temperature is not hot enough, then the control will fire the second boiler. There is a fixed 4°F (2°C) differential and an optional 5 minute delay between stages to ensure that the first boiler is operating continually before the second boiler will be fired. The other features and applications of this control will be described in the following pages.

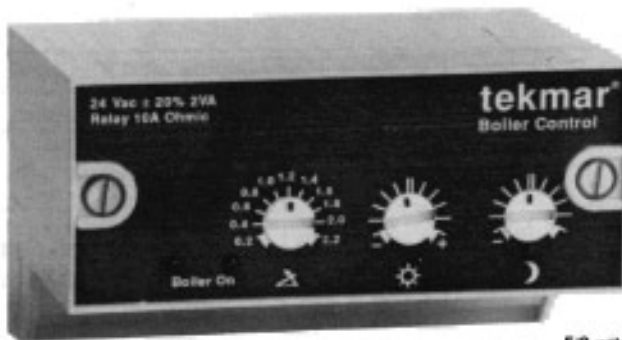

5/8 actual size

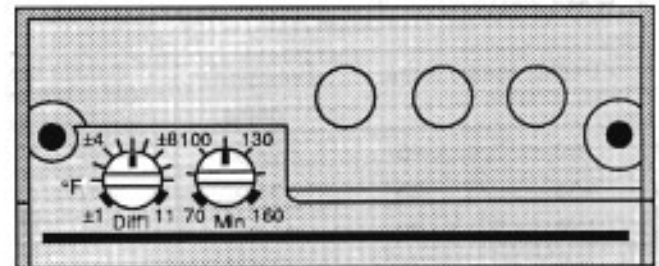

Back of the control showing the differential and minimum boiler temperature adjustments.

type 220 includes:

1. Electronic Control
2. Plug-in socket
3. Sensor (type 311) and strap
4. Outdoor sensor (type 315)

## Installation

### Mechanical:

The control's socket can be mounted on a DIN rail system or screwed to a flat surface.

### Electrical:

The tekmar control terminates the wires in a plug-in socket; no wires are directly connected to the control. This plug-in system simplifies installation and troubleshooting procedures. Terminals N & L (1 & 2) of the socket must be connected to the secondary side of a 24 Vac class 2 transformer. The total load of the control is approximately 2 VA.

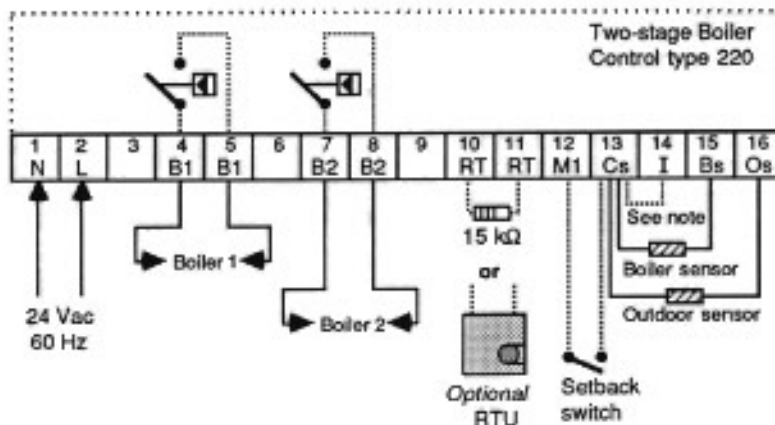

### Technical Data

Dimensions	4-1/4" x 2-7/8" x 2-1/2" (108 x 73 x 64 mm)
Weight	0.7 lbs (0.3 kg)
Power Supply	24 Vac ± 10%, 60 Hz, 2 VA, Class 2 Transformer
Relay Capacity	4 A Ohmic SPST
Ambient Operating Conditions	30 - 120°F (0 - 50°C) <95% RH Non-condensing

**Note:** The optional 5 minute delay between stages is enabled by installing a wire between terminals 13 & 14.

### Installation of the Sensors:

Note: The sensors are connected to the socket using a 2-conductor cable (eg. 2 x 18 AWG). The overall length of the cable can be 1700 ft. (500m) but the cable must not be run parallel to any power line or telephone cables.

#### 1. Boiler Sensor

Use the provided strap to fasten the boiler sensor to the (hot) boiler supply pipe just beyond the junction of the supply pipes from the boilers. In order to obtain exact temperature measurements, the brass sensor surface must be in tight contact with the pipe. Connect this sensor's two wire cable to terminals 13 & 15 of the socket. The strap-on sensor is not intended to be submerged in liquids.

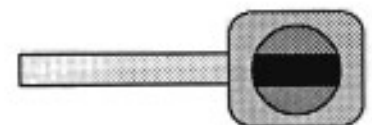
Strap-on sensor  
type 311

## 2. Outdoor sensor

The outdoor sensor should be mounted on the side of the building where the main, occupied rooms are. It should not be mounted immediately above a window or ventilation opening. With two round or pan head screws, attach the black base of the sensor to the wall. **The hole for the cable entry must face downward** for proper moisture drainage. Connect a two conductor cable, from the outdoor sensor terminals to terminals 13 & 16 of the control's socket.

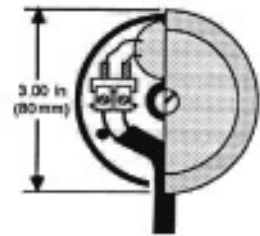

## 3. When installing an RTU, remove the 15 kΩ resistor.

Sensor temperature		Resistance	Sensor temperature		Resistance	Sensor temperature		Resistance
°F	°C	ohms	°F	°C	ohms	°F	°C	ohms
-50	-45	59,000	50	10	3,700	150	65	500
-30	-35	33,000	70	20	2,400	170	76	360
-10	-23	17,000	90	32	1,500	190	88	250
10	-12	10,000	110	43	1,000	210	100	180
30	0	5,600	130	54	720	230	110	140

## Adjustments

### 1. Differential

The differential adjustment sets how much the actual supply water temperature may deviate from the desired temperature before the boiler is turned on or off. To prevent short cycling of the boiler, the differential should be set slightly higher than one half the temperature rise through the boiler.

#### Example

$$\text{Temperature Rise} = \frac{\text{Btu/hr}}{\text{US GPM} \times 500} \quad \text{Eg: } \frac{90,000 \text{ Btu/hr}}{9 \text{ US GPM} \times 500} \approx 20^\circ\text{F}$$

The temperature rise is 20°F, so set the differential to more than ±10°F.

#### Example

$$\text{Temperature Rise} = \frac{\text{Watts}}{\text{litres/hr} \times 1.16} \quad \text{Eg: } \frac{9000 \text{ Watts}}{2000 \text{ l/hr} \times 1.16} \approx 4^\circ\text{C}$$

The temperature rise is 4°C, so set the differential to more than ±2°C.

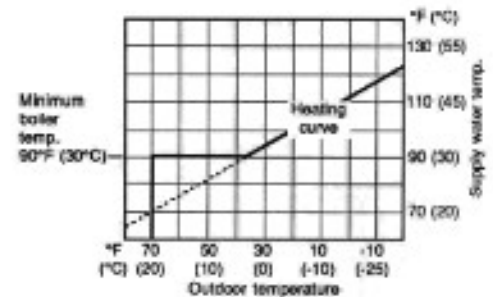
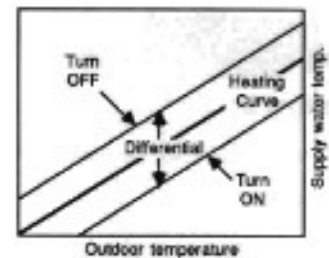

### 2. Minimum Boiler Operating Temperature

The range of adjustment is 70°F (20°C) to 160°F (70°C). This adjustment should be set to the boiler manufacturer's specification for the minimum allowable operating temperature of the boilers to prevent problems from condensation of the exhaust gases. For condensing boilers this adjustment should be set to 70°F (20°C).

### 3. Warm Weather Shut-Down

The boilers are shut-down whenever the outdoor air temperature exceeds 68°F (20°C). During setback this shut-down occurs at 40°F (5°C).

### 4. Heating Curve

The heating curve is the ratio of increase in supply water temperature to a one degree decrease in the outdoor ambient temperature. The correct adjustment of the heating curve is defined by the following formula:

$$\text{Heating curve} = \frac{\text{design supply temp.} - \text{room temperature}}{\text{room temp.} - \text{design outdoor temperature}}$$

#### Example

- Design outdoor temperature = -20°F (-30°C)
- Design room temperature = 70°F (20°C)
- Design supply temperature = 160°F (70°C)

$$\text{Heating curve} = \frac{160^\circ\text{F} - 70^\circ\text{F}}{70^\circ\text{F} - (-20^\circ\text{F})} = \frac{70^\circ\text{C} - 20^\circ\text{C}}{20^\circ\text{C} - (-30^\circ\text{C})} = 1.0$$

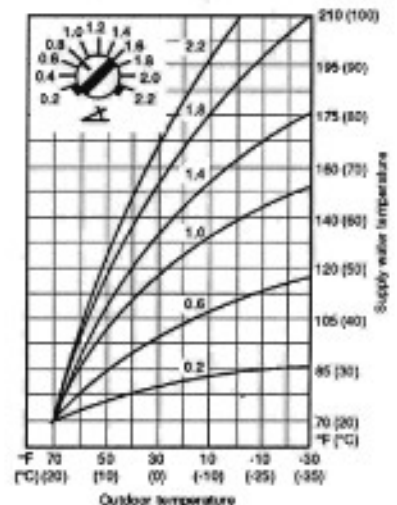

**5. Normal and Setback Operation (Parallel shifts)**

The ☀ knob shifts the heating curve during normal operation and the 🌙 knob shifts the heating curve during setback operation. Shifting the heating curve changes the room temperature. The '||' settings correspond to the 'as designed' condition. Shorting terminals 12 & 13 will cause the control to be in the setback mode and will result in a supply water temperature 20°F (10°C) lower than normal operation. Adjusting the knobs toward '+' or '-' changes the supply water temperature by approximately 4°F (2°C) per division.

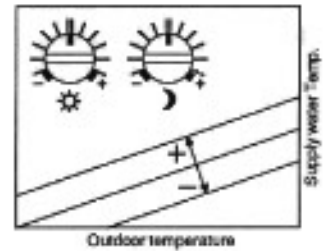

**6. Time Delay**

The second stage can either turn on as soon as the supply water temperature has drooped 4°F (2°C) below the switch on point of boiler 1, or 5 minutes after this droop has occurred. To enable the time delay, install a wire from terminal 13 to terminal 14 of the socket.

**Application #1:  
Two-Stage Control  
with a Mixing Valve  
Control & Conventional  
boilers.**

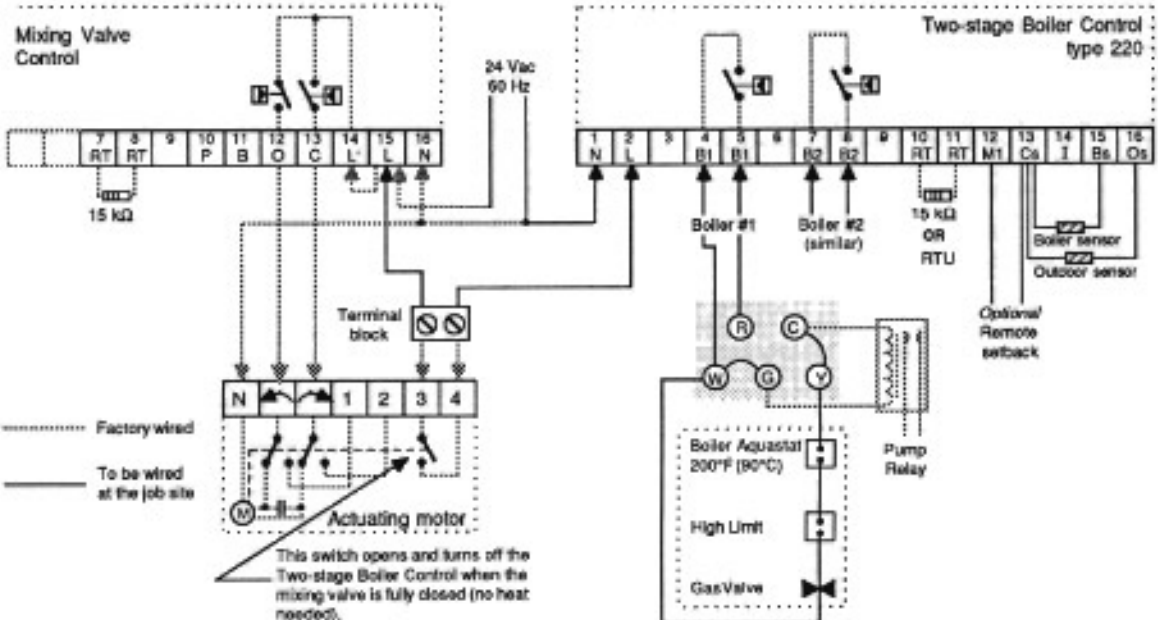
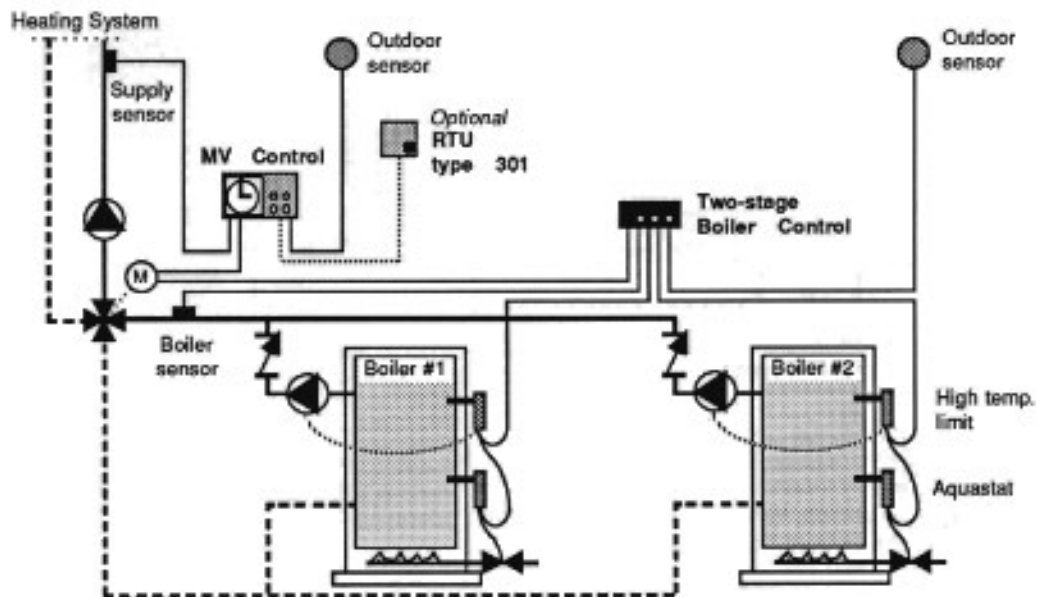

**Application #2: The Two-Stage Boiler Control as a complete heating system control.**

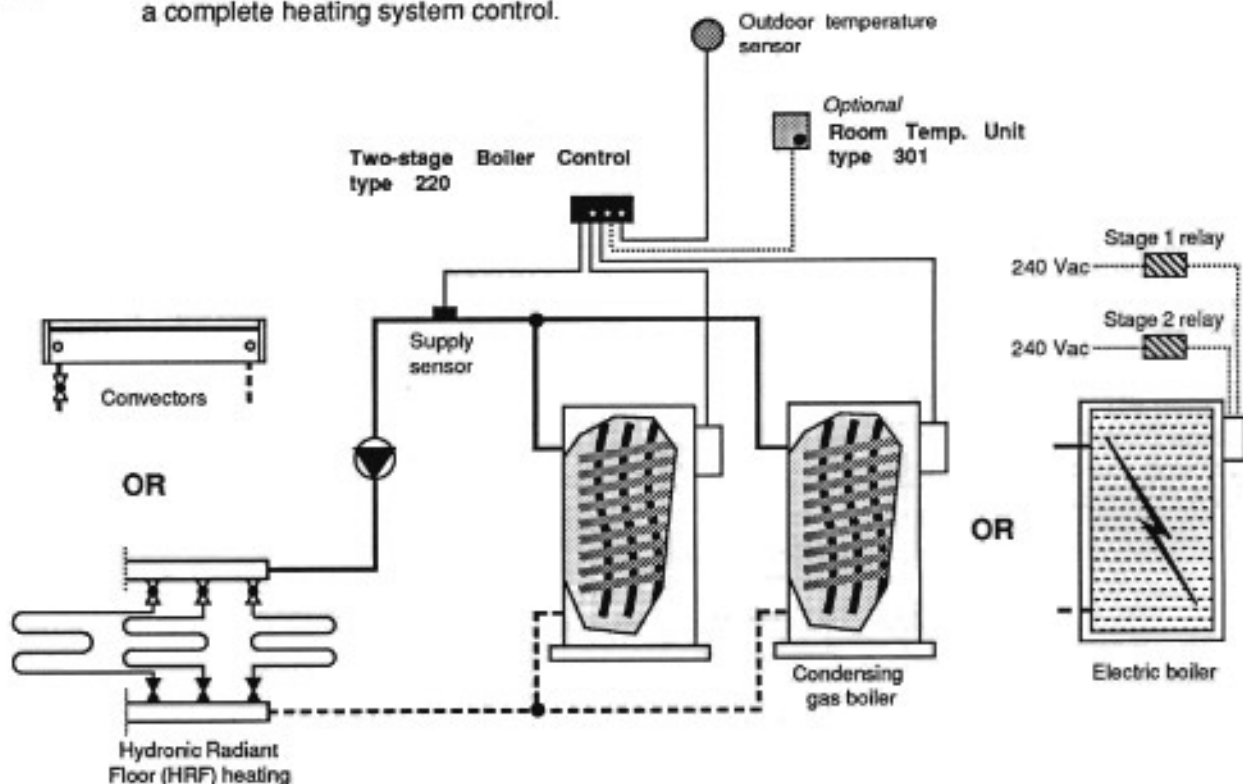

**Function:** The Two-Stage Boiler Control precisely regulates the supply water temperature from the boiler(s) as a function of the outdoor (and optionally indoor) air temperatures. The control initially regulates the supply water temperature by cycling the first boiler (or stage) on and off. When the first boiler (stage) is operating continually, but the supply water is not hot enough, then the control will cycle the second boiler (stage).

### Limited Warranty

tekmar Control Systems (tekmar®) warrants to the original purchaser, each tekmar product against defects in workmanship and materials, when the product is installed by a qualified person and used in compliance with tekmar's instructions. This warranty covers the cost of parts and labor provided by tekmar to correct defects in material and/or workmanship, but does not cover parts or labor to remove, transport or reinstall the defective product. tekmar will not be liable for any damage other than repair or replacement of the defective part or parts and such repair or replacement shall be deemed to be the sole remedy from tekmar. This warranty shall not apply to any defects caused or repairs required as a result of unreasonable or negligent use, neglect, accident, improper installation, or unauthorized repair or alterations.

In case of defect, malfunction or failure to conform to warranty, tekmar Control Systems will, for 24 months from the date of invoice or for 12 months from the date of installation of the product, whichever occurs first, repair or exchange at tekmar's

option, the defective product. The warranty is not in effect until the warranty card has been filled out and returned to tekmar Control Systems. Any express or implied warranty which the purchaser may have, including merchantability and fitness for a particular purpose, shall not extend beyond 24 months from the date of invoice or 12 months from the date of installation, whichever occurs first.

#### Warranty Procedure

The installer or other qualified service person must, at the owner's expense, determine which component has failed. If an actuating motor, electronic control, mixing valve, pump, sensor, or other tekmar component requires repair, only that component, together with the proof of purchase of the tekmar equipment must be returned to the original purchaser. In order for tekmar to process any warranty claim, the type number and fabrication number of the product and your name and address must be included with the defective component or product.

<b>In North America:</b>	tekmar Control Systems, Ltd., Canada tekmar Control Systems, Inc., USA Office: Site 15, Compartment 27, RR #6 Vernon, B.C. CANADA V1T 6Y5 Tel.: (604) 545-7749 Telex: 048-85384 Fax.: (604) 545-0650
<b>In Europe:</b>	tekmar Angewandte Elektronik GmbH & Co. KG Dückerstraße 4 D-4300 Essen 16, WEST GERMANY Tel.: (0201) 49841 Telex: 8579935