

Control Units types 101-106

The tekmar® Control Unit is the combination of a Motor-Electronic and a Pump-Mixer-Block. The Motor-Electronic and Pump-Mixer-Block can be purchased separately, or in one package as a Control Unit. If only the Pump-Mixer-Block is purchased, the installer can upgrade to a Control Unit with the purchase of a Motor-Electronic.

The Control Unit includes a zero maintenance Grundfos circulation pump, two thermometers, a four way mixing valve, a high torque actuating motor, a Mixing Valve Control or Mixing Valve & Boiler Control, temperature sensors, and the necessary hardware for a complete installation.



Control Unit with Mixing Valve Control

- Type 101** for 1" pipes with 3 speed pump UPS 15-42
- Type 102** for 1" pipes with pump UP 26-64
- Type 103** for 1" pipes with pump UP 43-75

Control Unit with Mixing Valve & Boiler Control

- Type 104** for 1" pipes with 3 speed pump UPS 15-42
- Type 105** for 1" pipes with pump UP 26-64
- Type 106** for 1" pipes with pump UP 43-75

Performance Curves:

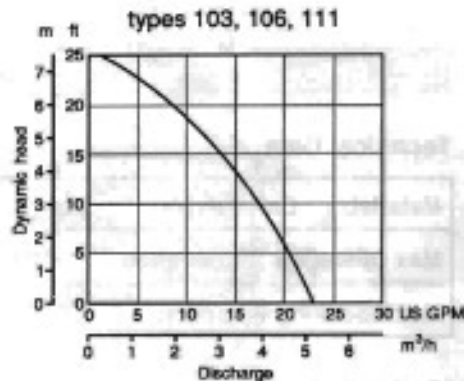
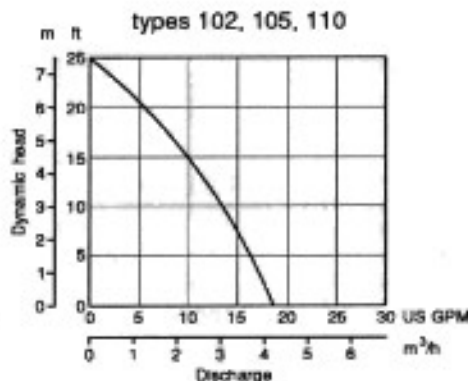
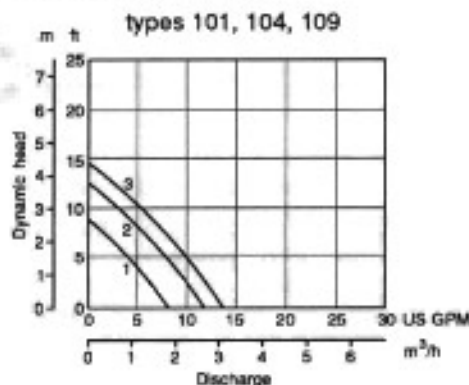

Typical Applications:

1. Types 101-103

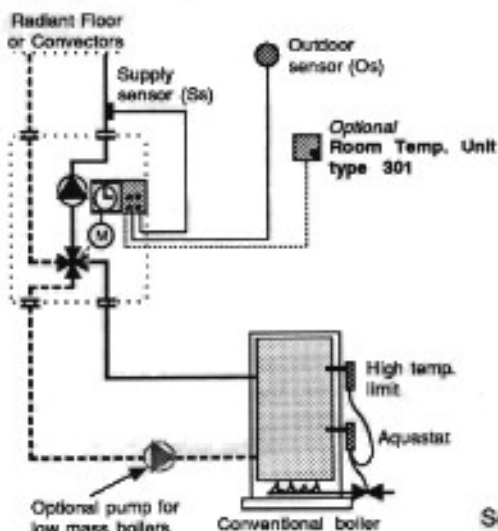

See T00

2. Types 104-106

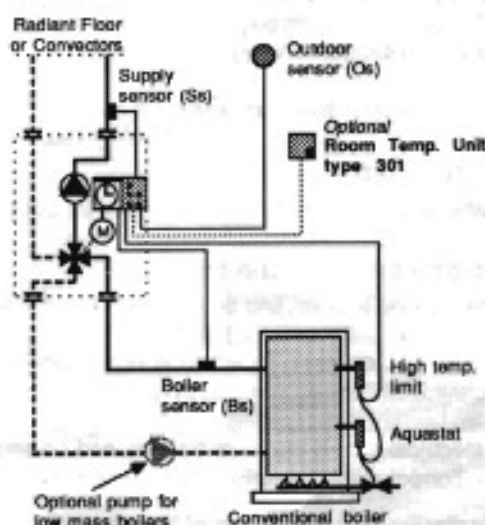

See T00

Installation of Control Units

Dimensional drawings:

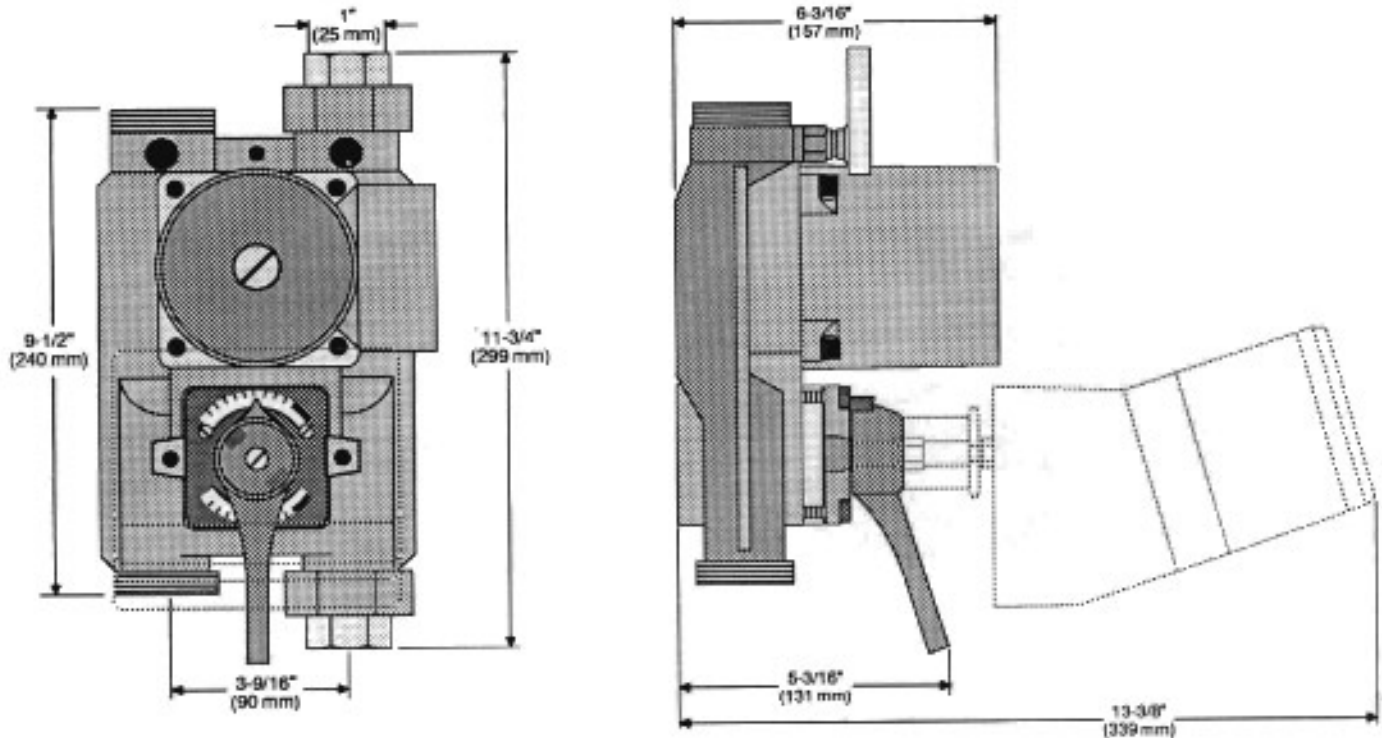

Technical Data:

Material:	Cast iron body & brass mixing valve
Max Operating Temperature:	230 °F (110°C)
Max Operating Pressure:	90 psi (600 kPa)

Caution

To reduce the risk of localized corrosion in the block we strongly recommend that iron pipes be installed between the boiler and the block and that an anti-corrosion agent be added to the heating system water.

Mechanical:

- Install the Control Unit in the plumbing.
- Generally the Control Unit will have enough mounting support from the pipes. However, if the 43-75 pump is used (types 103, 106, & 111), install a lag bolt through the 1/4" bolt hole at the top of the Pump-Mixer-Block casting and into a solid mounting surface. This will reduce the vibration loading on the pipes.
- Push the thermometers, using a back and forth twisting motion, into the wells. The O-ring provides a friction fit.

Wiring the Pump:

The circulation pump requires 117 Vac, 60 Hz. Connect line to terminal 'L', neutral to 'N', and ground to 'G'.

Start-up procedure for the pump:

- Fill the heating system and boiler circuit with water (and optionally glycol). Vent the system and open the isolation valves.
- Remove the indicator plug which is in the middle of the pump's nameplate. Insert a small screwdriver into the end of the shaft and gently rotate it until the shaft turns freely. When water begins to dribble out, replace and tighten the plug.
- The electrical supply can now be switched on and the pump started. On the variable speed pump select the rotation speed which gives the correct pump performance curve for the system.

For information on installation of the Motor-Electronic see brochure D03.

Pump-Mixer-Blocks types 109-111

The tekmar® Pump-Mixer-Block is a compact unit which includes supply and return thermometers, a self-lubricating circulating pump, a manually operated 4-way mixing valve, and NPT unions & gaskets.

The Pump-Mixer-Block is of cast iron construction with a brass valve mechanism and therefore should only be used in 'closed' heating systems. The valve shaft has double O-ring seals which enable it to withstand 90 psi (600 kPa) operating pressure. The operating temperature range for pure water is 34°F (1°C) to 230°F (110°C). For glycol solutions and other liquids the operating temperature range can be obtained by contacting tekmar® Control Systems.

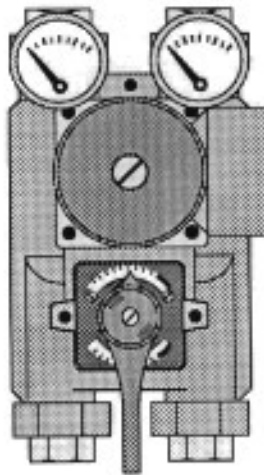

Pump-Mixer-Block

Type 109 for 1" pipes with 3 speed pump UPS 15-42

Type 110 for 1" pipes with pump UP 26-64

Type 111 for 1" pipes with pump UP 43-75

Types 109-111 include:

1. Supply and return thermometers
2. Grundfos® circulation pump
3. Four way mixing valve
4. Malleable iron pipe unions with gaskets

Pump performance curves are shown on page 1.
Installation instructions are on page 2.

Manual Operation of Pump-Mixer-Blocks

The tekmar® Pump-Mixer-Block can be manually operated to regulate the amount of heat being delivered into a building. The scale on the mixing valve is a relative indication of the amount of heat delivered. For example, during warmer weather, move the handle to 1 or 2, and during colder weather, to 7 or 8. The larger the number, the warmer the building will become. Due to the physical properties of hydronic radiant floor heating, there could be up to 2 hours delay from a change in the setting of the mixing valve to a change in the resulting room temperature.

9 = Hot

0 = Cold

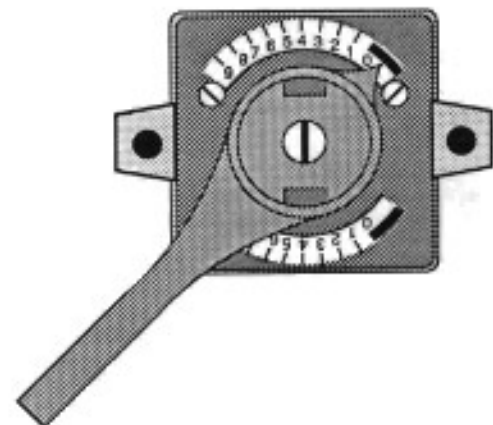

The adjacent graph shows the approximate energy savings of various automatic control upgrades. The Pump-Mixer-Block alone is the poorest control due to the lack of response to changes in outdoor air temperature. The tekmar Motor-Electronic with an RTU (Room Temperature Unit) is clearly the most energy efficient control strategy. The tekmar system also provides both increased comfort and extended system life due to precise regulation of the water temperature and programmable night setback.

For more information ask for the tekmar brochure T01: "Optimal Operation of Hydronic Heating Systems"

Pump-Mixer-Block (PMB)

PMB plus several thermostatic radiator valves

PMB plus an electronic room thermostat

PMB plus tekmar® Motor-Electronic and RTU

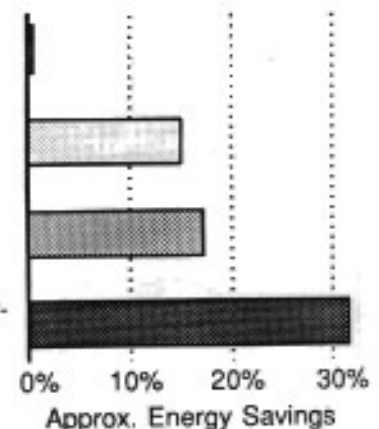

Pressure Activated Bypass type 113

The Pressure Activated Bypass is designed to mount on the top of the tekmar Control Unit or the tekmar Pump-Mixer-Block. It operates as follows. When the water flow in the heating system is decreased by closed zone valves then the pump runs up its operating curve and the pressure difference between the supply and return pipes increases; this in turn causes the Pressure Activated Bypass to open and thereby maintain water flow through the pump. The pressure difference between supply and return pipes at which the valve opens is adjustable from 1.5 to 20 feet of head (0.5 to 6.0 meters) and should be set equal to the design operating head for the system. Maximum flow through the valve is 15 US GPM (3.5 m³/hr). The maximum permissible water temperature is 250°F (120°C).

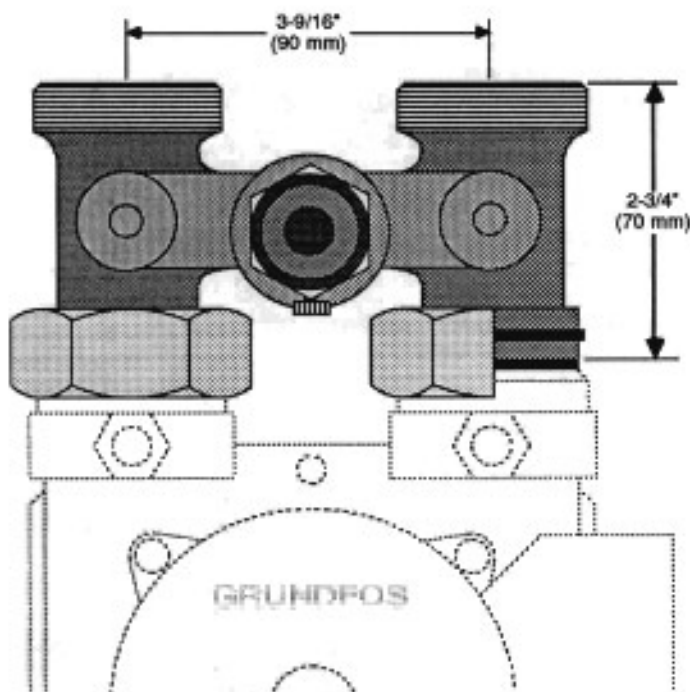

type 113 comes complete with:

1. Pressure Activated Bypass
2. Rubber gaskets

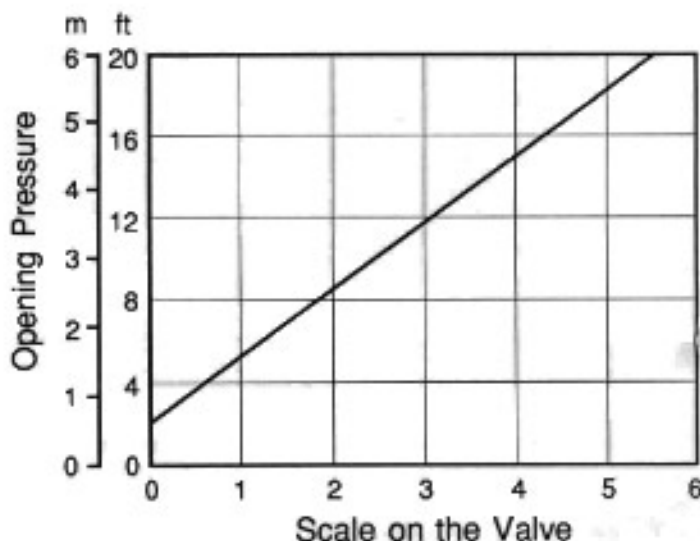

Limited Warranty

tekmar Control Systems (tekmar®) warrants to the original purchaser, each tekmar product against defects in workmanship and materials, when the product is installed by a qualified person and used in compliance with tekmar's instructions. This warranty covers the cost of parts and labor provided by tekmar to correct defects in material and/or workmanship, but does not cover parts or labor to remove, transport or reinstall the defective product. tekmar will not be liable for any damage other than repair or replacement of the defective part or parts and such repair or replacement shall be deemed to be the sole remedy from tekmar. This warranty shall not apply to any defects caused or repairs required as a result of unreasonable or negligent use, neglect, accident, improper installation, or unauthorized repair or alterations.

In case of defect, malfunction or failure to conform to warranty, tekmar Control Systems will, for 24 months from the date of invoice or for 12 months from the date of installation of the product, whichever occurs first, repair or exchange, at tekmar's

option, the defective product. The warranty is not in effect until the warranty card has been filled out and returned to tekmar Control Systems. Any express or implied warranty which the purchaser may have, including merchantability and fitness for a particular purpose, shall not extend beyond 24 months from the date of invoice or 12 months from the date of installation, whichever occurs first.

Warranty Procedure

The installer or other qualified service person must, at the owner's expense, determine which component has failed. If an actuating motor, electronic control, mixing valve, pump, sensor, or other tekmar component requires repair, only that component, together with the proof of purchase of the tekmar equipment must be returned to the original purchaser. In order for tekmar to process any warranty claim, the type number and fabrication number of the product and your name and address must be included with the defective component or product.

In North America: tekmar Control Systems Ltd., Canada
tekmar Control Systems Inc., USA
Office: #7 - 740 Waddington Drive
Vernon, B.C. CANADA V1T 8T6
Tel.: (604) 545-7749 Fax.: (604) 545-0650

In Europe: tekmar Angewandte Elektronik GmbH
Dückerstraße 4
D-4300 Essen 16, WEST GERMANY
Tel.: (0201) 49841 Fax.: (0201) 49935