

tekmar® - Data Brochure

Mixing Control 365



D 365
06/00



The tekmar Mixing Control 365 is a microprocessor-based control with a 120 Vac output for operating a variable speed injection pump. A 4-20mA output is available for operating devices such as a 4-20mA actuating motor, modulating gas valve, a mixing valve combination, or for operating a 4-20mA motor drive for larger variable speed pumps. The variable speed pump or mixing valve regulates the supply water temperature to a heating system based on the outdoor air temperature, and optionally, the indoor air temperature. The system is shut down when there is no Heat Demand signal or when the outdoor temperature is warm enough so that the system no longer requires heat (WWSD).

Outdoor Reset Strategy . .	pg. 2	Testing	pg. 13
Variable Speed Pump . . .	pg. 3	Error Messages	pg. 15
Sequence of Operation . .	pg. 5	Technical Data	pg. 16
Installation	pg. 7	Limited Warranty	pg. 16
Settings	pg. 11		

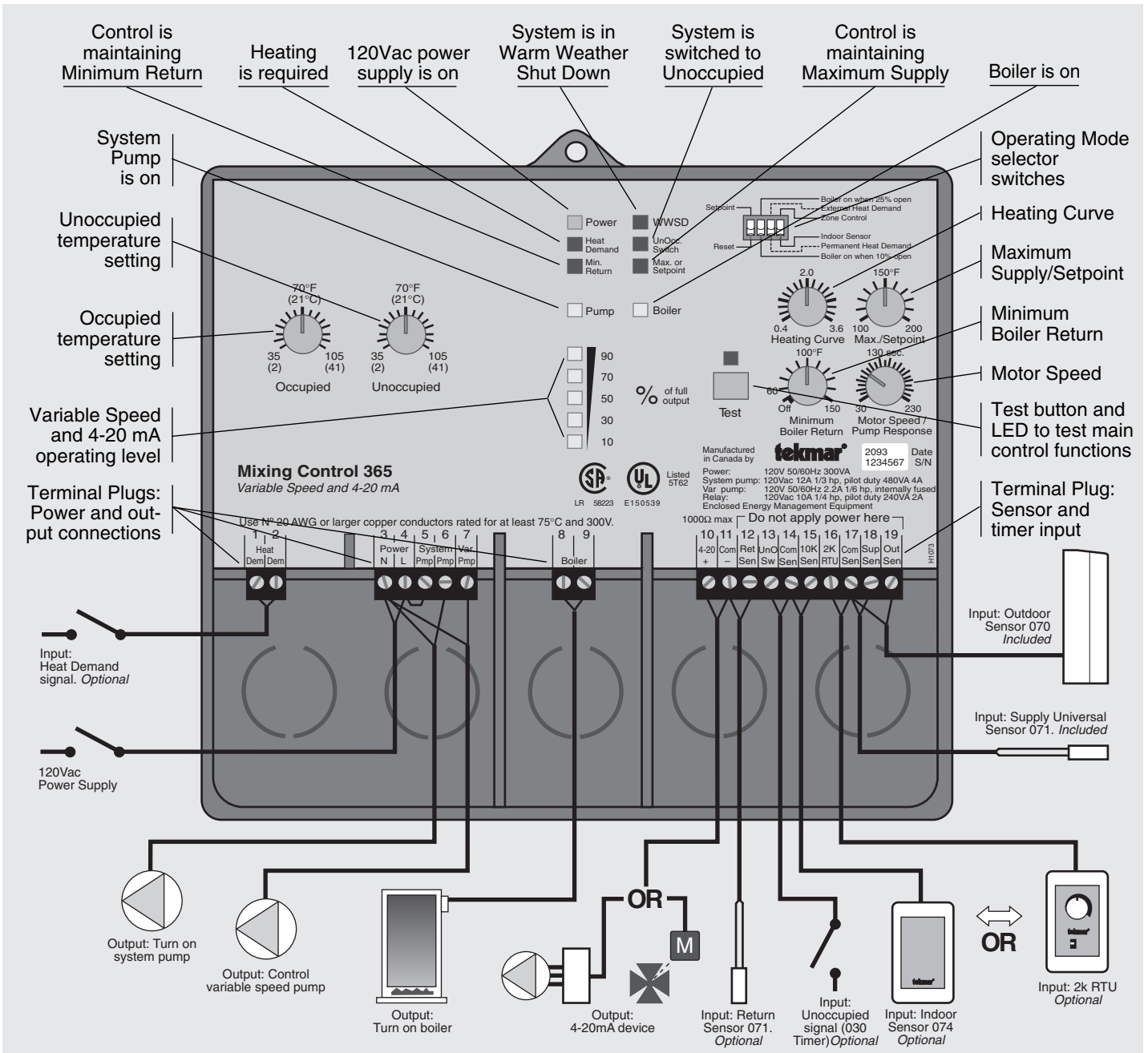

Outdoor Reset Strategy

Correct setting and shifting of the Heating Curve... the key to More Comfort and Energy Savings.

Heating Curve

As outdoor temperatures get colder, heat losses from a building increase, requiring the addition of more heat to prevent the indoor air temperature from also getting colder. This tekmar reset control measures the outdoor temperature and as the outdoor temperature gets colder, it balances the heat loss by making the heating supply water hotter.

The Heating Curve is used to calculate how hot to make the supply water at different outdoor temperatures. It is the number of degrees the supply water temperature is raised for each degree that the outdoor temperature falls.

Setting the Heating Curve

Two examples of how the Heating Curve works are given in the following illustration.

—With a 2.4 Curve, the supply water temperature is raised 2.4 degrees for every degree of outdoor temperature drop.

If WWSD point = 70°F and Outdoor temperature = 30°F, then Supply temperature = 166°F

—With a 0.6 Curve, the supply water temperature is raised 0.6 degrees for every degree of outdoor temperature drop.

If WWSD point = 70°F and Outdoor temperature = 30°F, then Supply temperature = 94°F

- If the Heating Curve selected is too low; the heating system will not be able to raise the supply temperature high enough to keep the room temperature warm during colder weather.
- If the Heating Curve selected is too high; too much heat is delivered and the building will overheat during colder weather.

Warm Weather Shut Down (WWSD)

At warm outdoor temperatures, the indoor space of a building gains heat from the outdoors; additional heat is not required, and if the heating system is running (even on standby), enough excess heat can be produced to overheat the building, causing discomfort and wasting valuable energy.

This control turns off the system pump and injection pump (or closes a mixing valve), when the outdoor temperature is above the WWSD point.

As outdoor temperatures get colder, there comes a point where the heat gain turns into heat loss; the heat loss causes the indoor temperature to fall below the comfort level, and the heating system must be turned on to start delivering heat.

To provide heat to the building, this control turns on the system pump and starts the injection pump (or opens the mixing valve), delivering heat at the low output required by the Heating Curve near the WWSD point. If the outdoor temperature rises above the WWSD point, the control shuts the system off again, and because the system was operating at a low heat output level, overheating and temperature swings in mild weather are avoided.

When the system is operating near the WWSD point and the building is too cold; the WWSD point should be raised.

When the system is operating near the WWSD point and the building is too warm; the WWSD point should be lowered.

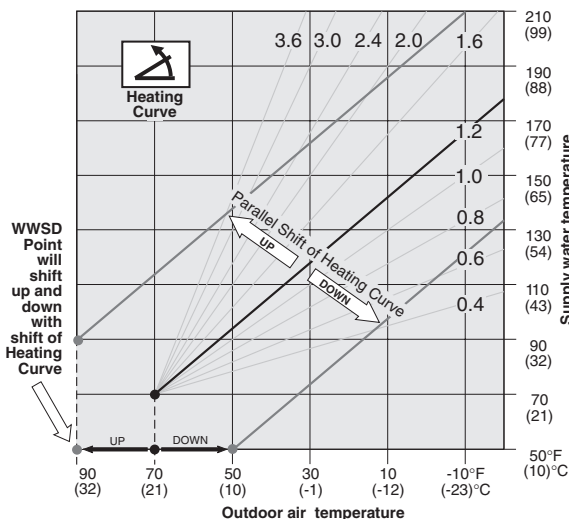
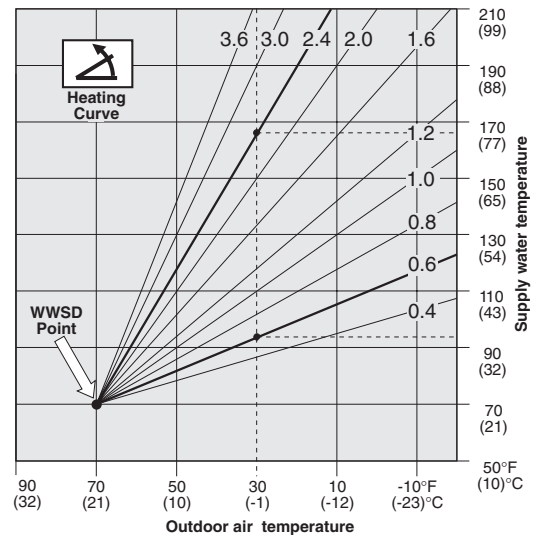

Shifting the Heating Curve

(a) Manually, at the control:

The Occupied and Unoccupied dials on this control can shift the WWSD point up or down from 35 to 105°F (2 to 41°C).

(b) Automatically, using room temperature feedback:

In addition to a Supply Sensor and an Outdoor Sensor, this control can use a tekmar 2k RTU, 10k Zone Control or 10k Indoor Sensor to provide room temperature feedback for added comfort and system flexibility.

The control still calculates a desired supply temperature based on the Heating Curve setting and the outdoor temperature.

If the air temperature in the room is too cold, the control will shift the Heating Curve (and WWSD point) *up*, which raises the supply temperature until the room warms up again.

If the air temperature in the room is too warm, the control will shift the Heating Curve (and WWSD point) *down*, which lowers the supply temperature until the room cools down.

A very cool room temperature can shift the curve far enough up to bring the control out of WWSD at warm outdoor temperatures. A very warm room temperature can shift the curve far enough down to put the control into WWSD at cool outdoor temperatures.

Refer to the tekmar Essays E 001 and E 002 for more detailed information regarding control strategy and integration of control functions.

The tekmar Variable Speed Pump Output

Variable Speed Pump

When using a variable speed pump, the injection of high temperature water into the lower temperature heating system loop should be continuous and the volume of water injected should be varied by speeding up (more heat) or slowing down (less heat) the pump rotation speed. This is a flexible and inexpensive method of mixing reset/setpoint control and can be used for a number of applications on systems with a wide variety of flow rates.

Ideally, the variable speed pump should operate near 100 % output during system design temperature conditions (when running in mixing reset mode). Injection rates will vary with changing high temperature loop water temperatures, and correct sizing of the injection pump must take this factor into account. Plumbing arrangements and pump sizing calculations are covered in more detail in the Essay E 021.

Operation

The Mixing Control 365 has a 120Vac 50/60Hz output which has been designed to directly power an injection pump at variable speeds to control the rate at which hot water is added to the heating system loop. The maximum drive capacity for this circuit is 1/6 hp, 2.2 Amp, 120Vac. There are a number of manufacturers producing small circulators that can be operated by this 120Vac output. A permanent capacitor, impedance protected pump motor (no start switch) under 1/6 hp is required. Most small "wet rotor" circulators have proven to be acceptable. Consult the accompanying Addendum for a list of the specific pumps tested and approved by their manufacturers. As these companies test and approve new products for use with the tekmar variable speed output, the Addendum will be updated.

Larger pumps require that a compatible 4–20 mA motor drive be used as an interface between the control and the pump motor. Contact the pump manufacturer regarding compatible equipment for specific pumps.

The variable speed (*Var Pmp*) and the 4–20 mA output operate at the same time. If the 120Vac output is used and remote monitoring is important, a remote read out via the 4–20 mA could be connected. The 4–20 mA is proportional to the level of the variable speed output.

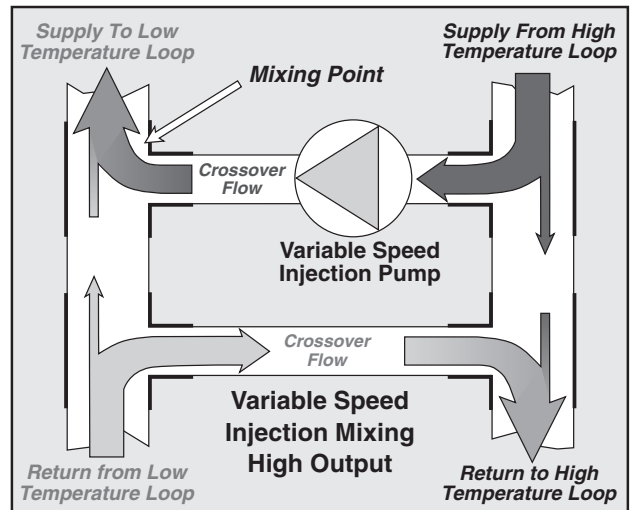
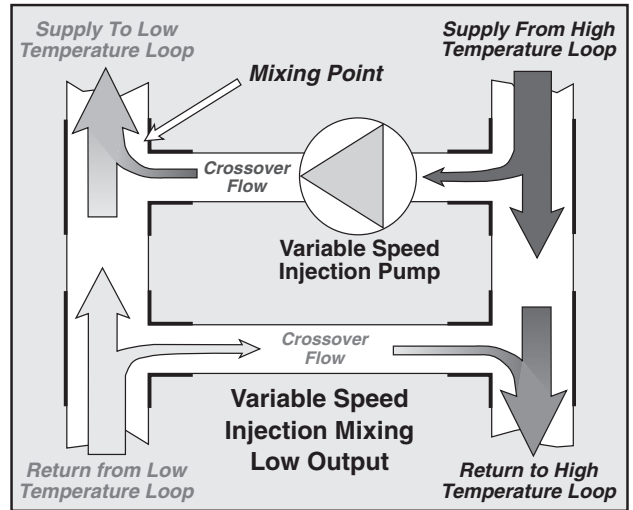

Variable Speed Pump Start Up

The control gives an initial 100% power output to the motor for 1/5 second to get it started up from a dead stop. This full power output is required to get the pump motor turning. After the 1/5 second starting pulse, the control adjusts the pump speed to meet the heating requirements.

The maximum *rate* at which the motor can change its speed from 0% output to 100% or from 100% output back to 0% output is set by the "Motor Speed/Pump Response" dial. This dial should be set according to system response times and will typically be set somewhere between 30 and 50 seconds. Refer to the "Settings" section, page 12, for more information.

% of Full Output

The control's variable speed output has been designed to provide a linear GPM flow rate over the full operating range of the pump. For example, when the "10 % of full output " LED is on, the control will be running the pump to deliver 10% of its GPM output rather than 10% of its rated rotational speed. As the above illustration indicates, the % output of flow from the pump is directly proportional (within 10%) to the "% of full output" scale of the control.

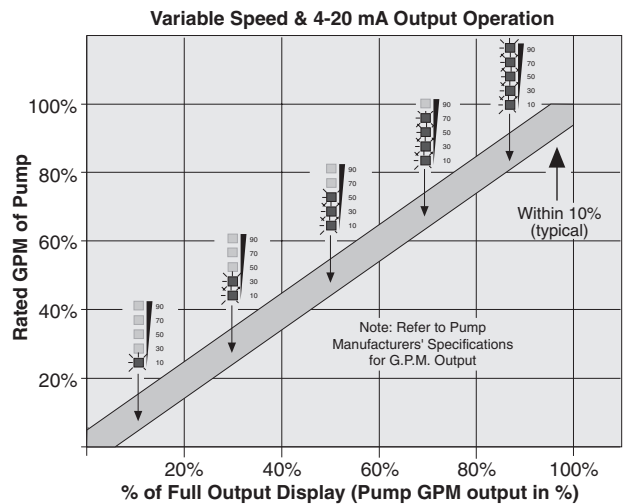

Plumbing Arrangements

tekmar has developed two significantly different ways of piping variable speed injection pumps for small commercial and residential hydronic heating systems. Each method has its advantages and disadvantages, and designers should read the tekmar essay E 021 thoroughly in order to correctly choose the best arrangement for their particular application.

Reverse Injection

Reverse injection requires that the water from the boiler loop is injected into the low temperature loop upstream of the return to the boiler loop. Mixing occurs directly after the point of injection. Since some of the mixed water is then returned back to the boiler loop, higher injection flow rates are required than in direct injection systems.

Pump Sizing
Reverse Injection *Maximum Variable Flow* $(F_v) = \frac{F_1 \times \Delta T_s}{T_1 - T_2}$

To calculate the required size of the injection pump:

- F1 = System Supply flow rate in US GPM
- T1 = Hot Loop (Boiler) supply temperature available
- T2 = Low Temperature (System) Supply temperature
- ΔT_s = Low Temperature (System) temperature drop ($T_2 - T_r$)

Note: All values are to be given at design conditions.

Sample Calculation

Values at Design Conditions	T1 = Boiler Supply = 180°F
	T2 = System Supply = 130°F
	ΔT_s = System ΔT = 25°F
Are:	F1 = System Flow = 10 GPM

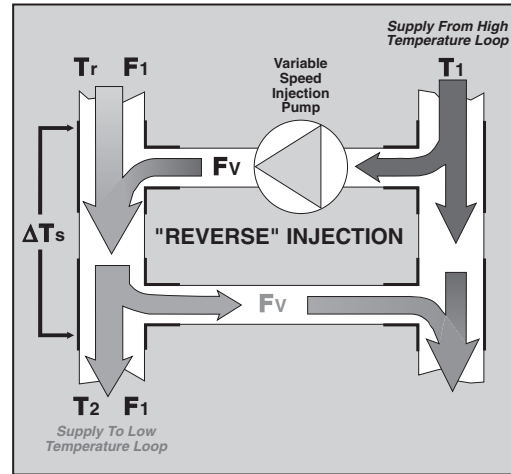

$$F_v = \frac{F_1 \times \Delta T_s}{T_1 - T_2} = \frac{10 \times 25}{180 - 130} = \frac{250}{50} = 5 \text{ GPM}$$

Direct Injection

Direct injection requires the water from the hot loop to be injected into the low temperature loop so that the heat rise and the mixing occur directly after the point of injection, downstream of the return to the hot loop.

Pump Sizing
Direct Injection *Maximum Variable Flow* $(F_v) = \frac{F_1 \times \Delta T_s}{T_1 - T_r}$

To calculate the required size of the injection pump:

- F1 = System Supply flow rate in US GPM
- T1 = Hot Loop (Boiler) supply temperature available
- T2 = Low Temperature (System) Supply temperature
- Tr = Low Temperature (System) Return temperature
- ΔT_s = Low Temperature (System) temperature drop ($T_2 - T_r$)

Note: All values are to be given at design conditions.

Sample Calculation

Values at Design Conditions	T1 = Boiler Supply = 200°F
	T2 = System Supply = 120°F
	ΔT_s = System ΔT = 20°F
Are:	F1 = System Flow = 60 GPM
	Tr = System Return = $T_2 - \Delta T_s = 100^\circ\text{F}$

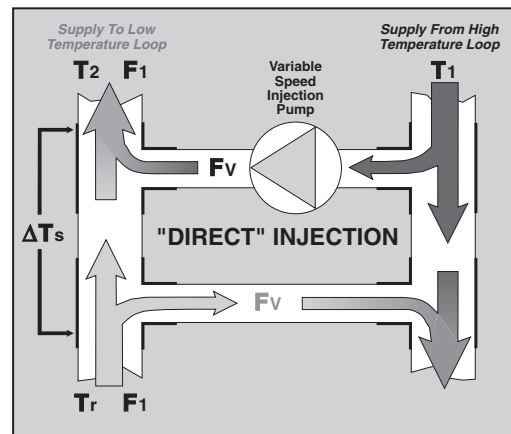

$$F_v = \frac{F_1 \times \Delta T_s}{T_1 - T_r} = \frac{60 \times 20}{200 - 100} = \frac{1200}{100} = 12 \text{ GPM}$$

This example illustrates an important point to consider when designing variable speed systems. The hotter the maximum boiler supply temperature is designed for, or the cooler the maximum system supply temperature is designed for, the less injection flow is required. Quite large systems can be designed with relatively small injection pumps when this is kept in mind.

For more details on variable speed pumping, refer to tekmar essay E 021

The variable speed injection pump should be sized for full load heat transfer at design conditions. Calculations reveal that in most typical residential and small commercial applications the smallest circulators are of sufficient size and in many cases exceed the maximum required GPM rating. If an appropriate pump size is not available, a larger pump may be used provided a balancing valve is included to reduce flow through the transfer loop.

Sequence of Operation

When the Mixing Control 365 is powered-up, the "Power" light will come on and the control will turn on all LEDs for five seconds. If no errors are detected, the control enters the operating mode.

Once in operating mode, the control determines whether to operate in Reset or Setpoint mode based on the setting of the Reset/Setpoint DIP switch.

If the control is configured for Setpoint it will monitor:

- a Universal Sensor 071 to continually monitor the system supply water temperature.
- *Optionally*, a Universal Sensor 071 to continually monitor the boiler return water temperature.

If the control is configured for Reset it will monitor:

- an Outdoor Sensor 070 to continually monitor the outdoor temperature.
- a Universal Sensor 071 to continually monitor the system supply water temperature.
- *Optionally*, a Universal Sensor 071 to continually monitor the boiler return water temperature.
- *Optionally*, the indoor temperature can be monitored through the use of:
 - (a) - a tekmar 2K RTU or 10K Indoor Sensor 074 (DIP switch in "Indoor Sensor" position) **or**;
 - (b) - a tekmar 10K Zone Control (DIP switch in "Zone Control" position)
- While monitoring all of these temperatures, the control recognizes the following temperature conditions and inputs and will respond as described. During operation, the lights of the control will indicate operational status as illustrated.

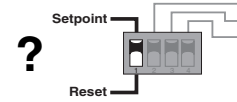
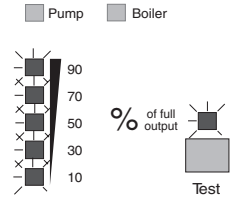
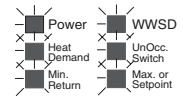

Heating Operation (Reset Mode) — Selector Switch = Reset

When the control is in the reset mode, its main function is to reset the supply water temperature based on the changing outdoor temperature.

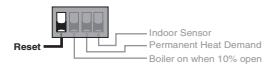

External Heat Demand signal — Selector Switch = External Heat Demand

A heat demand signal is caused by either 24 or 120Vac applied to terminals Heat Dem — Heat Dem (1 and 2).

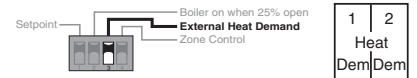

AND/OR

An active (calling for heat) 10 K Zone Control connected to terminals Com Sen — 10K Sen (14 and 15).



10	11	12	13	14	15	16	17	18	19
4-20	Com	Ret	UnO	Com	10K	2K	Com	Sup	Out
+	-	Sen	Sw	Sen	Sen	RTU	Sen	Sen	Sen

Permanent Heat Demand signal — Selector Switch = Permanent Heat Demand

A heat demand signal is continuously present unless a 10K Zone Control is connected to terminals Com Sen — 10K Sen (14 and 15). (If a 10K Zone Control is connected, there will only be a heat demand present when it calls for heat)

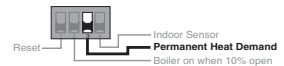

Occupied/Unoccupied dial function

With no indoor air temperature feedback, the control will monitor the outdoor and supply temperatures. The Occupied and Unoccupied dial settings become the WWSD points. When in Occupied mode and the outdoor temperature is warmer than the setting of the Occupied dial, the control enters WWSD. When switched into Unoccupied mode – Connect (short circuit) terminals UnO Sw — Com Sen (13 and 14) together by a switch or isolated timer relay contacts (tekmar Timer 030) – the "UnOcc. Switch" light will come on, the Occupied dial will become inactive and the Unoccupied dial will become active as the control starts to operate at the temperature of the Unoccupied dial setting.

10	11	12	13	14	15	16	17	18	19
4-20	Com	Ret	UnO	Com	10K	2K	Com	Sup	Out
+	-	Sen	Sw	Sen	Sen	RTU	Sen	Sen	Sen

Indoor Sensor 074 function — Selector switch = Indoor Sensor

The control will monitor the indoor, outdoor and supply temperatures, and shift the Heating Curve (and the WWSD point) up or down to fine adjust the system supply water temperature whenever the room temperature is different than the setting of the Occupied dial. When switched into Unoccupied mode, the "UnOcc. Switch" light will come on, and the control will operate at the temperature of the Unoccupied dial setting.

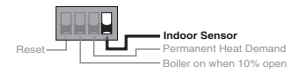

2K RTU function — Selector switch = Indoor Sensor

The control will monitor the indoor, outdoor and supply temperatures, and shift the Heating Curve (and the WWSD point) up or down to fine adjust the system supply water temperature whenever the room temperature is different than the setting of the RTU dial. The Occupied and Unoccupied dials are not functional. A Setback RTU 308 must be used if Unoccupied schedules are desired.

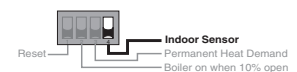

tekmar Zone Control function — Selector switch = Zone Control

The control accepts a zone input signal from a tekmar 10K Zone Control which monitors the indoor temperature of all zones – as well as the outdoor and supply temperatures – and shifts the Heating Curve (and the WWSD point) up or down to fine adjust the system supply water temperature for whichever zone requires the hottest supply water. The Occupied and Unoccupied dials are only functional if an external heat demand is given and the dial setting is higher than the zone control desired temperature.



WWSD function

When WWSD occurs, the "WWSD" light will come on, the 4-20 mA will go to 4 mA, the variable speed pump will be off, and the boiler and system pump will shut down. The control will continue to monitor the outdoor and supply temperatures. Whenever 3 days pass with the control in uninterrupted WWSD, the system pump will be cycled on for 10 seconds, the 4 to 20 mA mixing valve (if used) will be run open and then closed to help prevent seizing, and the variable speed pump (if used) will be turned fully on and then ramped off again. If a tekmar zone control is connected to this control, the system pump will only be turned off when the zone control does not require heat or the valve/injection pump is being exercised.

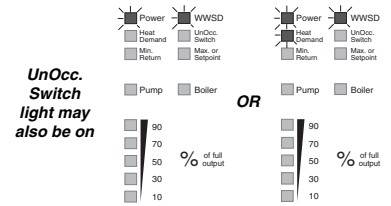

Outdoor temperature cold enough to require heating

Occupied/Unoccupied dial:

With no Heat Demand signal

When the outdoor temperature is colder than the WWSD point, the control will leave WWSD. Whenever the control leaves WWSD, the "WWSD" light will go out and the control will continue to monitor the outdoor and supply temperatures, but no further control action will take place unless there is a heat demand signal.

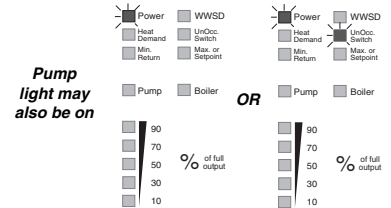

With Heat Demand signal

The "Heat Demand" light will come on, the control will switch on the system pump and boiler, and calculate the desired supply temperature based on the requirements of the Heating Curve.

The control will operate the 4-20 mA output and the variable speed pump to deliver the correct supply temperature. The 4-20 mA and variable speed pump output levels are displayed on the "% of full output" LEDs.

When controlling the 4-20 mA / variable speed pump, the control acts as follows:

- (a) - To increase the supply temperature. The 4-20 mA drive and variable speed pump output levels will increase at a rate determined by the control. The maximum rate is set at the Motor Speed/Pump Response dial.
- (b) - To decrease the supply temperature. The 4-20 mA drive and variable speed pump output levels will decrease at a rate determined by the control. The maximum rate is set at the Motor Speed/Pump Response dial.
- (c) - To maintain a steady supply temperature. The 4-20 mA drive and the variable speed pump output levels will remain relatively constant provided the heating load and boiler temperature does not change significantly.

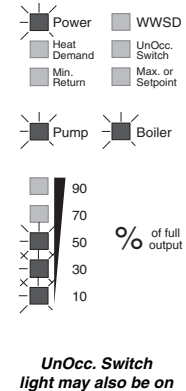

Maximum Supply temperature operation

To provide a measure of protection to system components that may be damaged by excessive heat, (e.g.. some types of plastic pipe) this control has a setting for Maximum Supply temperature.

When the supply temperature is close to the setting on the Max./Setpoint dial, the control will reduce the "% of output" in order to keep the supply water temperature below the maximum setting. At this time the "Max. or Setpoint" light will come on.

The control may operate for a long time at the Maximum temperature if:

- (a) - it is coming out of a deep setback or just starting up from a cold start;
- (b) - an RTU (or Occupied dial when Indoor Sensor 074 is used) is turned up suddenly; or
- (c) - the maximum setting is too low for system design conditions.

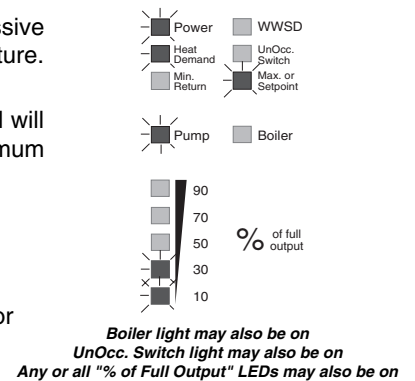

Minimum Boiler Return temperature operation

To provide a measure of protection to boilers that may have minimum return water temperature requirements, this control has a setting for Minimum Boiler Return temperature.

When the boiler return temperature is close to the setting on the Minimum Boiler Return dial, the control will decrease the "% of output" in order to increase the boiler return temperature and prevent undershoot. The "Min. Return" light will come on and the control will continue to decrease the output in order to maintain the temperature slightly above the Minimum Boiler Return temperature setting. The "Boiler" light will be on as the control continues to fire the boiler (even below the 10%/25% open settings) in order to raise the return temperature.

The control may operate for a long time at the Minimum temperature if:

- (a) - it is coming out of a deep setback or just starting up from a cold start;
- (b) - an RTU (or Occupied dial when Indoor Sensor 074 is used) is turned up suddenly;
- (c) - the Minimum setting is too high for system design conditions; or
- (d) - the boiler aquastat is set lower than the "Minimum Boiler Return" dial setting.

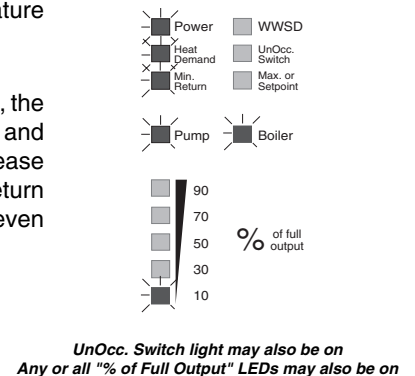

Notes on operation of Minimum Return and Maximum Supply functions

At times, the control may be trying to control both the Maximum Supply and Minimum Return temperatures (e.g.. when leaving a deep setback). When this occurs, the control is programmed to give priority to the Minimum Boiler Return function, and only the "Min. Return" light will be displayed.

When the control is in WWSD, the "Min. Return" and "Max. Supply" lights will not be displayed.

When using a Return Sensor for Minimum Return protection, it is essential that there always be water flow past the return sensor whenever there is a heat demand. See Brochure A 365.

Caution:

The tekmar Mixing Control 365 is an operating control and not certified or intended for use as a primary safety device. Under normal operating conditions, the control will provide excellent protection against excessive supply temperatures and low boiler return temperatures; However, if fail-safe protection against either of these conditions is essential then separate certified safety limit devices should be employed.

Setpoint Operation ——— Selector Switch = Setpoint

When the control is in the Setpoint mode, it will control the supply water temperature based on the setting of the Max./Setpoint dial. The Outdoor Sensor need not be installed and the Occupied, and Heating Curve dials are inactive. If the control receives an Unoccupied signal, the supply temperature will be controlled at the setting of the Unoccupied dial. When an optional Boiler Return Sensor 071 is installed, the Minimum Boiler Return function is activated based on the setting of the "Min. Return" dial.



External Heat Demand signal ——— Selector Switch = External Heat Demand

A heat demand signal is caused by either 24 or 120Vac applied to terminals Heat Dem — Heat Dem (1 and 2). This signal will activate the control, allowing it to operate the system to deliver the selected setpoint temperature.

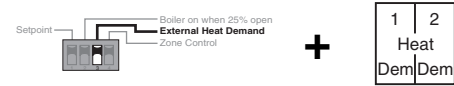

AND/OR

An active (calling for heat) 10 K Zone Control connected to terminals Com Sen — 10K Sen (14 and 15).

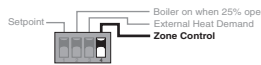

10	11	12	13	14	15	16	17	18	19
4-20	Com	Ret	UnO	Com	10K	2K	Com	Sup	Out
+	-	Sen	Sw	Sen	Sen	RTU	Sen	Sen	Sen

Permanent Heat Demand signal ——— Selector Switch = Permanent Heat Demand

A heat demand signal is continuously present and the control will continuously operate the system to deliver the selected setpoint temperature.

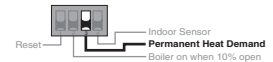

Installation

Caution

Improper installation and operation of this control could result in damage to equipment and possibly even personal injury. It is your responsibility to ensure that this control is safely installed according to all applicable codes and standards.

Step One ——— Getting ready

Check the contents of this package. If any of the contents listed are missing or damaged, please refer to the Limited Warranty and Product Return Procedure on the back of this brochure and contact your wholesaler or tekmar sales agent for assistance.

- Type 365 includes:
- One Control 365
 - One Outdoor Sensor 070
 - One Universal Sensor 071
 - One Data Brochure D 365
 - One Data Brochure D 001
 - One Application Brochure A 365
 - One Essay E 021

Other information available:

- Essay E 001
- Essay E 002

Read Brochure A 365 and E 021 and select the correct Application for your job.

Note:

Carefully read the details of the Application, and the Sequence of Operation sections in all applicable brochures to ensure that you have chosen the proper control and understand its functions within the operational requirements of your system. Some applications feature boiler return protection and require an additional Universal Sensor 071 to be ordered.

Step Two ——— Mounting of the base

The control should be removed from its base by pressing down on the release clip in the wiring chamber and sliding upwards on the control. The base is then mounted in accordance with the instructions in the Data Brochure D 001.

Step Three ——— Rough-in Wiring

All electrical wiring terminates in the control base wiring chamber. It has standard 7/8" (22mm) knock-outs that will accept common wiring hardware and conduit fittings. Before breaking out the knock-outs, check the wiring diagram and select those sections of the chamber with common voltages, since the safety dividers will later prevent wiring from crossing between sections.

Power should not be applied to any of the wires during this rough-in wiring stage.

- Install the Outdoor Sensor 070, and the Universal Sensor 071 according to the instructions in the Data Brochure D 001 and run the wiring back to the control.

Rough-in wiring (continued)

Option: A Universal Sensor 071 can be installed to provide Minimum Boiler Return protection. See Brochure A 365.

Option: A 10K Indoor Sensor 074, 2K RTU or 10K Zone control can also be connected. See the instructions with these products.

- Install the wiring from the other system components (Boiler, System Pump, Actuating Motor, Heat Demand circuit) to the base.
- Install 120Vac to the power terminals on the control. *Use a clean 120 Vac power source to ensure proper operation.*

Step Four Electrical connections to the control

Power and output connections

The installer should test to confirm that no voltage is present at any of the wires.

- Install the control into the base, sliding it down until it snaps into place.
- All electrical connections are made directly to the plug terminals.
- Connect the 120Vac power supply to terminals *Power N* — *Power L* (3 and 4).

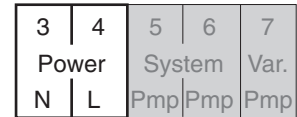

System Pump

- Connect the System Pump circuit to terminals *System Pmp* — *System Pmp* (5 and 6). These terminals lead to a dry relay contact which closes when the control requires System Pump operation.

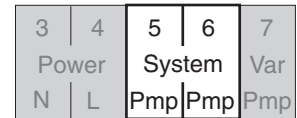

Boiler

- Connect the boiler circuit to terminals *Boiler* (8 and 9). These terminals lead to a dry relay contact which closes when the control requires boiler operation. Boilers with a 24Vac to 120Vac control circuit can be switched directly through the control.

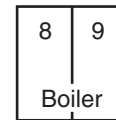

120Vac Variable Speed Pump

- Connect one of the variable speed pump leads to the 120Vac neutral terminal "Power N" (terminal 3).
- Connect the other variable speed pump lead to terminal "Var Pmp" (terminal 7).

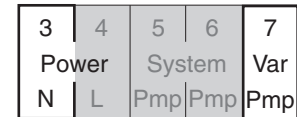

Output To Variable Speed Pump
(Maximum 1/6 hp)

Caution:

The maximum variable speed pump load is 1/6 hp, 120Vac. Pumps must be permanent capacitor, impedance protected, with locked rotor current not exceeding 2.2 amps.

The Mixing Control 365 has an internal, slow blow 2.5 Amp fuse for the variable speed pump output. If the maximum load is exceeded – causing this fuse to blow – the control must be returned to tekmar where it will be examined for damage, repaired if necessary, and the fuse replaced. This procedure will not be covered as a warranty claim.

4- 20 mA Connections

The 4-20 mA output can be used to operate a variety of actuating motors for mixing valves and motor drives for larger pumps. Consult the manufacturers' installation instructions for these devices for more details on these connections.

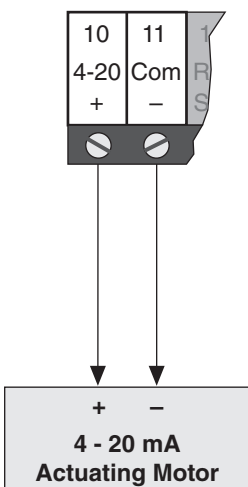

Connection to Operate a 4 - 20 mA Device

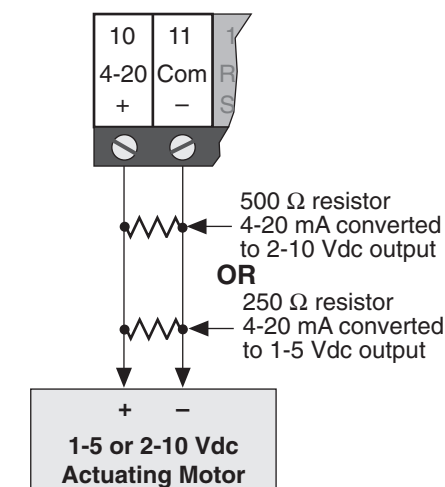

Converting the 4 - 20 mA Output to Operate a 1 - 5 Vdc or 2 - 10 Vdc Device

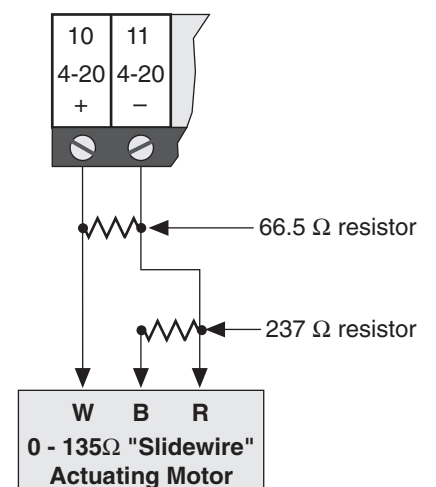

Converting the 4 - 20 mA Output to Operate a 0 - 135Ω Actuating Motor

Powered input connections

If a 24Vac to 120Vac external heat demand signal is used, (zone valve end switches, etc.) connect the wiring from the Heat Demand circuit to terminals *Heat Dem* — *Heat Dem* (1 and 2). When 24Vac to 120Vac is applied to these terminals, the control will respond to a call for heat from the system.

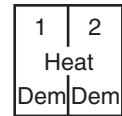

Sensor and unpowered input connections

Power should never be applied to these terminals. Damage to the control will result.

Connect the two wires from the Outdoor Sensor 070 to terminals *Com Sen* — *Out Sen* (17 and 19).

Do not apply power here!

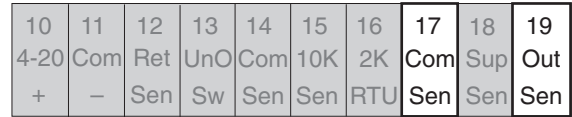

Connect the two wires from the Universal Sensor 071 – which should be mounted on the system supply pipe – to the terminals *Com Sen* — *Sup Sen* (17 and 18).

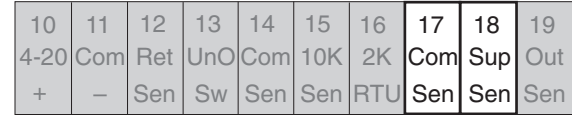

Option: Boiler Return temperature sensor (Must be ordered separately)

Connect the two wires from the Universal Sensor 071 to terminals *Com* — *Ret Sen* (11 and 12).

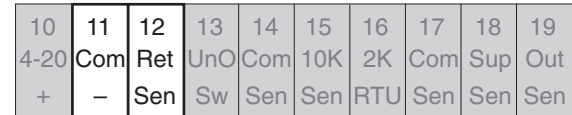

Option: Indoor temperature feedback sensor (Select one option only)

(1) Connect the two wires from the Indoor Sensor 074 or a tekmar 10K Zone Control to terminals *Com Sen* — *10K Sen* (14 and 15).

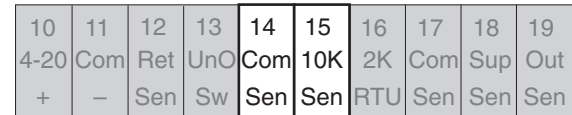

OR

(2) Connect the two wires from the tekmar 2K RTU or the tekmar 2K Zone Control type 240 to terminals *2K RTU* — *Com Sen* (16 and 17).

OR

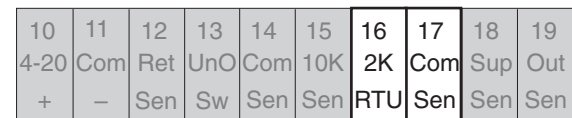

Option: Occupied/Unoccupied switch input

Connect the two wires from the Occupied/Unoccupied dry contact switch, (tekmar Timer 030) to terminals *UnO Sen* — *Com Sen* (13 and 14).

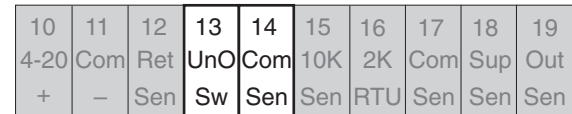

Electrical connections to the terminal plugs of the type 365 control. Control relays are shown in "power down" condition.

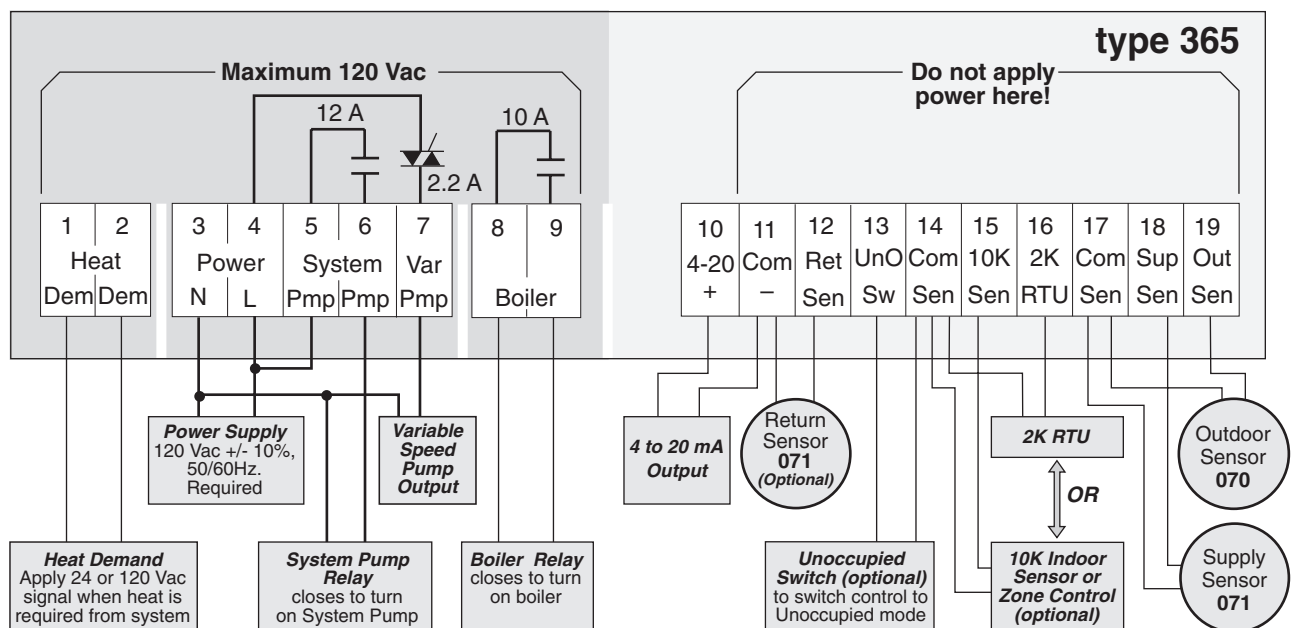

Note: This is not a wiring Diagram

For a detailed wiring schematic of your specific application, refer to the Application Brochure A 365.

Step Five ■ Testing the wiring

Caution

Before applying power to the control for testing, each terminal plug must be unplugged from its header on the control. Pull straight down to unplug.

These tests are to be performed using standard electrical testing practices and procedures and should only be carried out by properly trained and experienced persons.

A good quality electrical test meter, capable of reading from at least 0 — 200 Volts AC, and at least 0 — 1,000,000 Ohms, is essential to properly test this control.

Test the sensors

These test must be made *before* turning on the power supply, and with the terminals unplugged. The sensors are to be tested according to the instructions in brochure D 001. If a tekmar RTU or Zone Control is used, check the applicable data brochure for the product used.

Test the power supply

Make sure exposed wiring or bare terminals are not in contact with any other wires or grounded surfaces. Turn on the 120 Vac power and use an AC voltmeter to measure the voltage between terminals *N — L* (3 and 4). Between 110 and 130 Vac should be measured at these terminals.

Test the powered inputs

If an external Heat Demand signal is used, power up the Heat Demand circuit and supply a Heat Demand signal to the control. Use an AC voltmeter to measure the voltage between terminals *Heat Dem — Heat Dem* (1 and 2). From 22 to 130 Volts AC should be measured at these terminals.

Test the outputs

If a System Pump circuit is connected to the *Sys Pmp — Sys Pmp* (5 and 6) terminals; make sure power to the circuit is off and install a jumper in the terminal plug between terminals 5 and 6. When the system Pump circuit is powered-up, the pump should operate. If it does not come on, check the circuit wiring for errors and ensure that it is powered up and the voltage is correct. Check the devices in the circuit (pump, switching relay, etc.) for faults. If the pump operates properly when the circuit is powered up disconnect the power, remove the jumper and proceed to the next step.

Note: When a Return Sensor 071 is used, the boiler loop pump must operate with the system pump. See Brochure A 365.

If you are using the control to operate the boiler; make sure power to the boiler circuit is off and install a jumper in the terminal plug between the *Boiler* (8 and 9) terminals. When the boiler circuit is powered-up, the boiler should operate. If it does not come on, check the circuit wiring for errors and ensure that it is powered up and the voltage is correct. Check the devices in the circuit (limits, flow switches, etc.) for faults. If the boiler operates properly when the circuit is powered up, disconnect the power, remove the jumper and proceed to the next step.

If a Variable Speed Pump is connected to the *Power N — Var Pmp* (3 and 7) terminals; make sure power to the circuit is off and install a jumper in the terminal plug between *L — Var Pmp* (4 and 7) terminals. When 120 Vac supply is powered up, the variable speed pump should operate. If the pump operates properly when the circuit is powered up, disconnect the power, remove the jumper and proceed to the next step. During operation, this output from the control can be measured with a standard voltmeter. Push the test button, and monitor the voltage at terminals 3 & 7. At 100% output the voltage should read between 90 and 130Vac.

Connect the control

Turn the power off and make sure all test jumpers have been removed from the plugs.

- Connect the plugs to the control by carefully aligning them with their respective headers and pushing them upwards into the headers. The plugs should snap firmly into place.
- Install the supplied safety divider(s) between low voltage and high voltage wiring chambers.
- The control is now ready for set-up and operation.

Testing the 4-20 mA output

The 4-20 mA output terminals (10 and 11) cannot be tested without power being applied to the control. If you are going to be using this output, connect an ammeter to the 4-20 mA output terminals (10 and 11) and observe the current reading during operation. Refer to the Sequence of Operation section of this brochure for details on 4-20 mA output levels.

Caution

The tekmar Mixing Reset Control 365 is an operating control and is not certified or intended for use as a safety device. Under no circumstances should safety limit devices be left disconnected after installation of this control. The installer shall check all applicable code requirements and obtain necessary inspections to ensure that the installation is in compliance with those requirements.

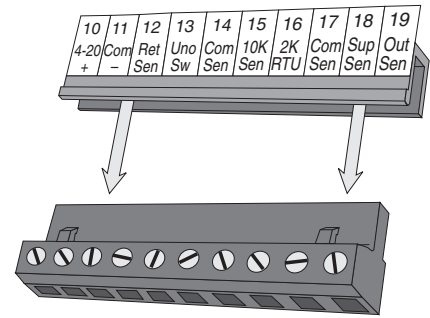

Terminal plug disconnected from its header on the control

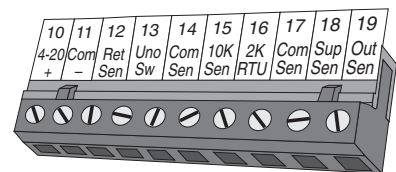

Terminal plug pushed into its header on the control

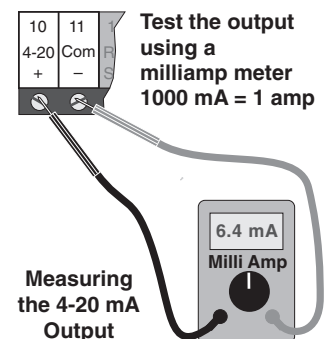

Settings

Step Six Essential control settings

To obtain the best operation from a reset control, it is important to measure the system supply temperature as accurately as possible. Whenever the control receives a heat demand signal, the system pump must be operated to maintain continuous water flow across the supply temperature sensor. Whenever the control uses a boiler return sensor, the boiler pump must also be operated to maintain continuous water flow across the boiler return sensor.

For specific application details refer to Brochure A 365.

A more detailed technical description of the effect of control settings on overall system operation is described in the tekmar Essay, E 002.

Heating Curve

As outdoor temperatures drop, heat losses from a space become greater and the heating system supply water temperature must be raised to maintain a constant room temperature. The heating curve value describes how many degrees the supply water temperature is raised for a one degree drop in outdoor temperature. The supply temperature starts to increase when the outdoor temperature falls below the WWSD point. To calculate the correct setting for the heating curve, use the following formula.

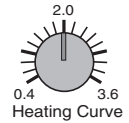

$$\text{Heating Curve} = \frac{\text{design supply temperature} - \text{room temperature}}{\text{room temperature} - \text{design outdoor temperature}}$$

- For example:
- Design outdoor temperature = 5°F (-15°C)
 - Room temperature = 70°F (21°C)
 - Design supply temperature = 160°F (71°C)

$$\text{Heating curve} = \frac{160^{\circ}\text{F} - 70^{\circ}\text{F}}{70^{\circ}\text{F} - 5^{\circ}\text{F}} = \frac{90^{\circ}\text{F}}{65^{\circ}\text{F}} = 1.4$$

For more information regarding the Heating Curve, refer to page 2 of this brochure. If the design supply water temperature for a system is unknown, a trial setting can be calculated using these typical supply temperatures:

- Fan coils ... 180° to 210°F (82° to 99°C)
- Baseboard convectors ... 160° to 190°F (71° to 88° C)
- Hydronic radiant floors ... 100° to 130°F (38° to 54°C).

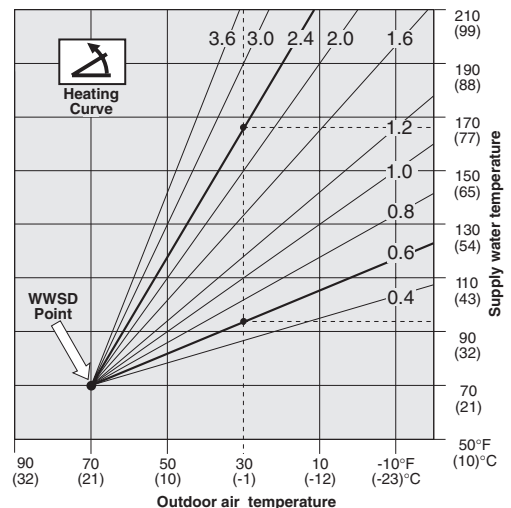

Occupied temperature

When there is no room temperature feedback to the control, the Occupied dial setting determines the starting point of the Heating Curve. This starting point becomes a fixed WWSD point.

When an Indoor Sensor 074 is connected to the control, the Occupied dial setting becomes the actual controlled temperature of the room. This allows the control to compensate for unexpected internal heat gains or losses. If the room temperature is too high or too low, the indoor sensor shifts the Heating Curve up or down accordingly. Except when there is an external heat demand, when a Zone Control or RTU (Room Temperature Unit) is connected, the RTU dial(s) set the desired room temperature and the Occupied dial becomes inactive.

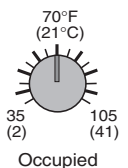

Unoccupied temperature

The Unoccupied dial operates in the same way as the Occupied dial, but at a different temperature.

When the terminals *UnO Sw — Com Sen* (13 and 14) are shorted together, the control switches from operating at the Occupied dial setting to operating at the Unoccupied dial setting. When a tekmar Zone Control or RTU (Room Temperature Unit) is connected to the control, the RTU setting(s) becomes the controlled temperature and the Occupied/Unoccupied dials become inactive. Unoccupied temperatures must be controlled at the zones.

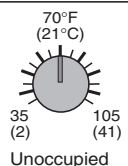

Indoor Sensor/Zone Control switch

Set this selector switch to the "Indoor Sensor" position when a tekmar Indoor Sensor 074 or a tekmar RTU is connected. The control will receive room temperature feedback from the room that has the Sensor or RTU.

Set the switch to the "Zone Control" position when a tekmar Zone control is connected, the control receives information from the Zone Control that allows the Heating Curve to be shifted so the supply water temperature is hot enough to satisfy the requirements of the zone with the highest heat demand.

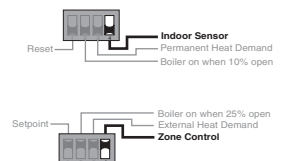

Setpoint/Reset switch

When this selector switch is in the "Setpoint" position, the control will operate the system to maintain the supply water temperature at the setting of the "Max./Setpoint" dial.

When the switch is in the "Reset" position, the Heating Curve is active, and the "Max./Setpoint" dial becomes an override to the Heating Curve, limiting the maximum allowable water temperature.

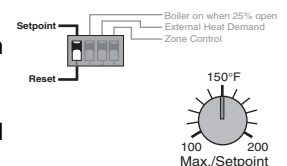

Heat Demand switch

When the heating system uses zone valve end switches or some other means of delivering an external heat demand signal to terminals *Heat Dem* — *Heat Dem* (1 and 2), set this switch to "External Heat Demand" and the control will only operate the system pump, boiler and mixing device when it receives a 24/120 Vac signal from the heat demand circuit. If a 10K Zone control (tekmar 366) is connected to terminals 10K Sen — Com Sen (14 and 15), the zone control may also call for heat.

If an external heat demand signal is not used, set the switch to "Permanent" and the control will be enabled all the time unless a 10K zone control is connected.

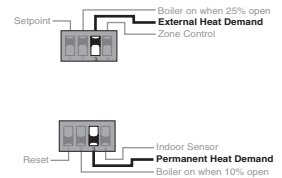

Maximum Supply temperature

This setting determines the maximum allowable supply temperature to be delivered to the system. When the supply temperature becomes too hot, the variable speed pump slows down – or the mixing valve closes – until the temperature is stabilized at the maximum. To get the fastest system heat up times, this setting should be set as high as allowable. Refer to page 6 for more details on maximum supply operation and requirements.

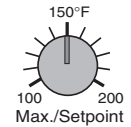

Minimum Boiler Return temperature

When a Boiler Return Sensor 071 is connected to the control, and the dial is turned up from "Off", this setting determines the minimum allowable boiler return temperature. When the boiler return temperature becomes too cold, the variable speed pump slows down – or the mixing valve is closed – until the temperature is stabilized at the minimum. To minimize standby losses and get the fastest system heat up times, this setting should be set as low as allowable. Refer to page 6 for more details on minimum boiler return operation and requirements.

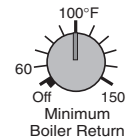

Boiler Enable switch

The position of this switch determines at which pump/valve position the control will fire the boiler under normal conditions. If there is a Return Sensor 071 installed and the return temperature is too cold, the control will immediately turn on the boiler in order to raise the water temperature more quickly.

At the "10% open" position, the control will not fire the boiler until the pump/valve has opened at least 10%, and will turn the boiler off when the pump/valve closes to 5% open. This setting would normally be chosen for high mass boilers (cast iron, steel fire tube, etc.), or systems with a large thermal mass in the loop between the boiler and the mixing pump/valve.

At the "25% open" position, the control will not fire the boiler until the valve has opened at least 25%, and will turn the boiler off when the valve closes to 15% open. This setting would normally be chosen for low mass boilers (copper fin tube, etc.), and systems with low thermal mass in the loop between the boiler and the mixing pump/valve.

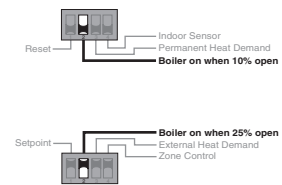

Note:

Some heating systems combine high input, low mass boilers with very little thermal mass in the loop between the boiler and mixing pump/valve. In some extreme cases, erratic boiler action (short cycling and tripping of high limits) may result from this type of system even at the "25% open" position. To prevent this type of operation it may be necessary to add thermal mass to the system by installing a storage tank or making the loop larger.

Motor Speed/ Pump Response

The type of device being controlled, and the length of time required for the system to respond to a control action will determine the setting for this dial.

Motor Speed (4-20 mA valve output)

When operating a valve, the control uses the information from this setting to synchronize the firing of the boiler to the valve position. Set this adjustment to match the time required for the actuating motor to drive from the fully closed to the fully open position.

If you are unsure of the opening time, complete the following procedure:

- (1) Make sure the actuating motor/mixing valve is in the fully closed position.
- (2) Set the "Motor Speed/Pump Response" dial to the longest (fully clockwise) position.
- (3) Power up the control and push the Test Button.
- (4) Observe the motor as it is driven open by the test routine. When the motor reaches its fully open position by stopping against its end switch, turn the dial down just until the control cycles through to the next step in the test routine.
- (5) The "Motor Speed/Pump Response" dial is now set to the operating speed of the actuating motor. Let the control cycle through to the end of the test routine.

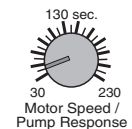

Motor Speed/ Pump Response (variable speed pump)

When using a variable speed system pump, this dial adjusts the amount of time required for the injection pump to go from 0% to 100% flow when maximum output is required, and from 100% back to 0% when no output is required. The output response of the variable speed pump depends on the magnitude of the controlling error (calculated from the readings the control is receiving from the sensors).

Experimentation may be necessary in some systems to avoid instability (pump continually ramping up to 100% output and back down), but most standard heating installations work best with settings in the 30 to 50 second range.

Testing the Control Functions

Indicator lights

There are fourteen LEDs on the front of the control that will aid in testing and troubleshooting. During normal operation, these lights indicate the following functions:

- Power light on** • the 120 Vac power supply has been connected and the control is energized.
- Heat Demand light on** • the control is receiving a 24 or 120 Vac external heat demand signal at terminals *Heat Dem*—*Heat Dem* (1 and 2) or from a 10K Zone Control or the heat demand selector switch is in the "Permanent Heat Demand " position.
- WWSD light on** • the control has calculated that the outdoor temperature is warm enough to not require heat.
- Unoccupied light on** • the terminals *Uno Sw*—*Com Sen* (13 and 14) are shorted together, switching the control into the Unoccupied (setback) mode.
- Min. Return light on** • the control is operating the mixing valve (4-20 mA) or variable speed pump (Var Pmp) to satisfy the minimum boiler return temperature requirement.
- Max. or Setpoint light on** • the control is operating the mixing valve (4-20 mA) or variable speed pump (Var Pmp) to prevent maximum supply temperature overshoot, or the control is operating in the setpoint mode.
- Boiler light on** • the boiler relay is on, closing the contacts between the *Boiler* (8 and 9) terminals.
- Pump light on** • the system pump relay is on, closing the contacts between the *System Pmp* (5 and 6) terminals.
- % of full output lights on** • the control is displaying the output level of both the 4-20 mA output (from terminals 10 and 11) and the Variable Speed Pump output (from terminals 3 and 7) in incremental % levels.
- Test light on** • the control is going through the programmed test routine.

Step Seven Operational test of control functions - Test button

Test button

When the settings are made and the terminal plugs firmly seated, power up the control. For approximately 5 seconds, all the red LED status lights and the yellow "% of full output" lights are turned on. If a fault in a sensor exists, the LED lights will flash an error message until the fault is located and corrected. The error messages are listed on page 15.

If there are no flashing error messages, the control will enter the operating mode. To initiate the test routine, press the Test button.

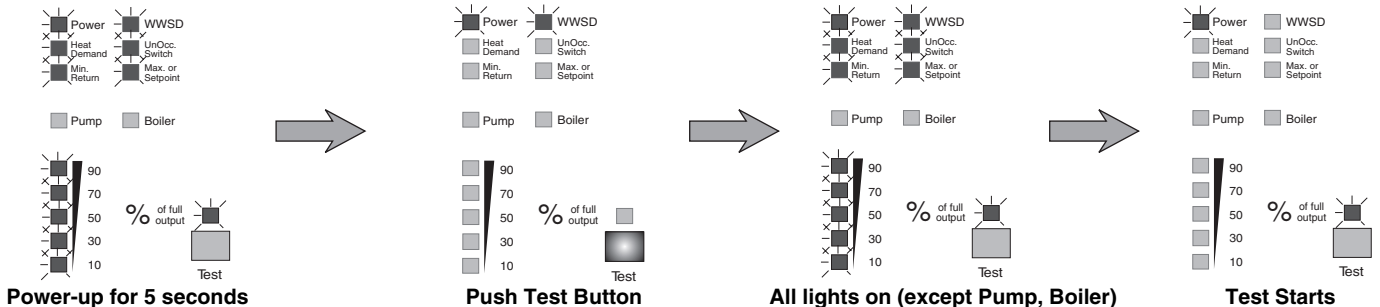

Power light on — Test light on — Increasing "% of full output" lights on

The control ramps the variable speed pump and the 4-20 mA output up to 100% together, in the time set by the "Motor Speed/ Pump Response" dial.

If the Test Button is pushed once during this step, the "Test" light will flash and the control will be held in a pause mode for 5 minutes, after which time it will automatically exit the test routine and return to normal operating mode. Pushing the Test button during the 5 minute pause will allow the control to resume the test routine at the next step.

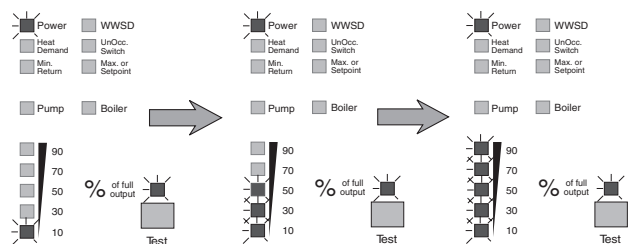

Power light on — Test light on — all "% of full output" lights on — System pump on

Once 100% output on the 4-20 mA and variable speed injection pump has been reached, the control will then begin to ramp down the output and turn the system pump on.

During this 10 second step, if there is a heat demand signal, and the Test button is pressed once, the test routine will be halted and the system pump will remain on. The "Test" light will flash, and the control will be held in a pause mode for 5 minutes, after which time it will automatically exit the test routine and cycle into normal operating mode. Pushing the Test button during the 5 minute pause will allow the control to resume the test routine at the next step.

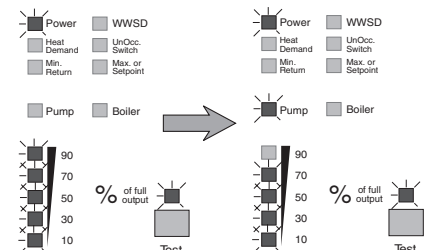

Power light on — Test light on — Decreasing "% of full output" lights on — System Pump light on — Boiler light on

After 10 seconds of the system pump running the control leaves the system pump on and turns on the boiler relay for 10 seconds.

During this 10 second step, *if there is a heat demand signal, and* the Test button is pressed, the test routine will be halted and the system pump and boiler will remain on. The "Test" light will flash, and the control will be held in a pause mode for 5 minutes, after which time it will automatically exit the test routine and cycle into normal operating mode. Pushing the Test button during the 5 minute pause will allow the control to resume the test routine at the next step.

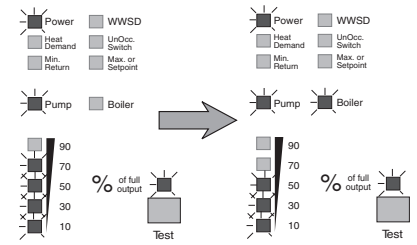

Power light on — Test light on — Decreasing "% of full output" lights on

The control turns off the boiler and system pump and continues to ramp down the 4-20 mA / Variable speed pump outputs.

If the Test button is pushed once during this step, the "Test" light will flash, and the control will be held in a pause mode for 5 minutes, after which time it will automatically exit the test routine and cycle into normal operating mode. Pushing the Test button during the 5 minute pause will allow the control to exit the test routine.

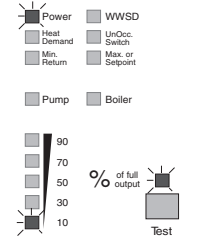

Power light on — Test light off

The control has exited the test routine, entered operating mode and will function according to the sequence of operation described on pages 5, 6 & 7. *One or more of the indicator lights may be on.* Refer to pages 5, 6 & 7 for a description of the possible indicator light combinations under operating conditions.

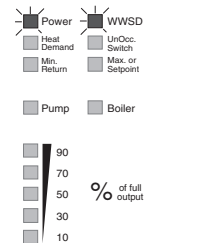

Step Eight Troubleshooting

As in any troubleshooting procedure, it is important to isolate a problem as much as possible before proceeding. The Error Messages and Test button greatly simplify troubleshooting of the Mixing Control 365. When the control is flashing an Error Message, identify the fault from the look-up table on the next page and then follow standard testing procedures to confirm the problem. If you suspect a wiring fault, return to steps four and five and carefully check all external wiring and wiring connections.

Notes:

When a fault occurs in Reset Mode

- If the Outdoor Sensor develops either a short circuit or an open circuit, the control is programmed to calculate the outdoor temperature at 32°F (0°C), and control the supply temperature accordingly, subject to the limit of the supply maximum setting. An error message will then be displayed (see error messages).
- If the Supply Sensor develops either a short circuit or an open circuit, the control is programmed to fully close the mixing valve and turn off the variable speed pump and boiler. An error message will then be displayed (see error messages).
- If a 2k RTU or a 10k Indoor Sensor or Zone Control is connected and an open circuit develops, the control will operate at the setting of the Occupied and Unoccupied dials. No error message will be generated.
- If a short circuit develops at either the 2k RTU – Com Sen or 10k Sen – Com Sen terminals, the control will operate at the setting of the Occupied and Unoccupied dials. An error message will then be displayed (see error messages).
- If a Boiler Return Sensor is connected and an open circuit develops, or if no sensor is installed but the "Minimum Boiler Return" dial is set up from the off position. An error message will then be displayed (see error messages).
- If a short circuit develops at the boiler return sensor terminals, the Boiler Return function will become inactive. An error message will then be displayed (see error messages).
- If the enclosure overheats, the control will shut down its outputs and display an error message (see error messages) until it cools off again. Check to ensure that the ambient temperature is less than 104°F(40°C).

When a fault occurs in Setpoint Mode

- A short circuit or an open circuit at the Outdoor Sensor terminals will not affect the operation of the control. In the case of a short circuit, an error message will be displayed (see error messages). An open circuit will not cause an error message to be generated.
- If the Supply Sensor develops either a short circuit or an open circuit, the control is programmed to fully close the mixing valve and turn off the variable speed pump and boiler. An error message will then be displayed (see error messages).
- A short circuit or an open circuit at the 2k RTU or a 10k Indoor Sensor or Zone Control terminals will not affect the operation of the control if these terminals are not being used. In the case of a short circuit, an error message will be displayed (see error messages). An open circuit will not cause an error message to be generated.
- If a short circuit develops at either the 2k RTU – Com Sen or 10k Sen – Com Sen terminals, the control will operate at the setting of the Occupied and Unoccupied dials. An error message will then be displayed (see error messages).
- If the enclosure overheats, the control will shut down its outputs and display an error message (see error messages) until it cools off again. Check to ensure that the ambient temperature is less than 104°F(40°C).

- If a Boiler Return Sensor is connected and an open circuit develops, or if no sensor is installed but the "Minimum Boiler Return" dial is set up from the off position. An error message will then be displayed (see error messages).
- If a short circuit develops at the boiler return sensor terminals, the Boiler Return function will become inactive. An error message will then be displayed (see error messages).

After any repair has been completed, press the Test button to confirm that correct operation has been restored.

Error Messages

Whenever a fault is detected in any of the sensors, the indicator lights will flash in specific ways, indicating the location of the problem. The following look-up table describes each error condition and shows the flashing light sequence that results. After repairing the problem, press the Test button to cycle the control through the test routine. This will confirm that the fault has been repaired and that correct control action has been restored. For detailed sensor testing instructions see Data Brochure D 001.

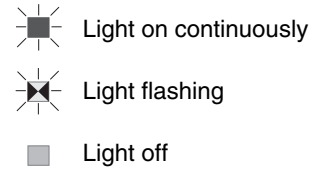

<p>Outdoor Sensor short circuit (see troubleshooting notes)</p>	<p>Supply Sensor short circuit (see troubleshooting notes)</p>	<p>Boiler Return Sensor short circuit (see troubleshooting notes)</p>
<p>Outdoor Sensor open circuit (see troubleshooting notes)</p>	<p>Supply Sensor open circuit (see troubleshooting notes)</p>	<p>Boiler Return Sensor open circuit (see troubleshooting notes)</p>
<p>RTU short circuit (see troubleshooting notes)</p>	<p>10K Indoor sensor short circuit (see troubleshooting notes)</p>	<p>Enclosure Over-heated (see troubleshooting notes)</p>

Step Nine Before you leave

- Install the wiring cover over the wiring chamber and secure it to the base with the two screws provided. Place the front cover on the control to cover the setting dials and snap it into place. Install a lock if security is required.
- Place this brochure, and all other brochures relating to the installation, in the protective plastic bag supplied with the control. Place the bag in a conspicuous location near the control for future reference.
- It is important to explain the operation and maintenance of this control and of the system to the end user and anyone else who may be operating the system.

Specifications

Mixing Control 365 Variable Speed / 4 - 20 mA

Literature	— D 365, A 365's, D 001, D 070, E 021.
Control	— Microprocessor PID control; This is not a safety (limit) control .
Packaged weight	— 3.3 lb. (1500 g), Enclosure A, blue PVC plastic
Dimensions	— 6-5/8" H x 7-9/16" W x 2-13/16" D (170 x 193 x 72 mm)
Approvals	— CSA, UL listed, meets ICES & FCC regulations for EMI/RFI.
Ambient conditions	— Indoor use only, 30 to 105°F (0 to 40°C), < 90% RH non-condensing.
Power	— 120 V (ac) ±10% 50/60 Hz 300 VA
System Pump	— 120 V (ac) 12 A 1/3 hp, pilot duty 480 VA 4 A
Var. Pump	— 120 V (ac) 50/60 Hz 2.2 A 1/6 hp, internally fused
Boiler Relay	— 120 V (ac) 10 A 1/4 hp, pilot duty 240 VA 2 A
Demands	— 24 to 120 V (ac) 2 VA
Sensors included	— NTC thermistor, 10 kΩ @ 77°F (25°C ±0.2°C) β=3892 Outdoor Sensor 070 and Universal Sensor 071.
Optional devices	— tekmar type #: 031, 071, 072, 073, 076, 077, 367, 368, 369.
Occupied	— 35 to 105°F (2 to 41°C)
Unoccupied	— 35 to 105°F (2 to 41°C)
Heating Curve	— 0.4 to 3.6
Maximum Supply	— 100 to 190°F, Off (38 to 88°C, Off)

Setpoint & UnOcc	— 35 to 200°F (2 to 93°C)
Min. Boiler Return	— Off, 60 to 150°F (Off, 16 to 66°C)
Motor Speed	— 30 to 230 seconds

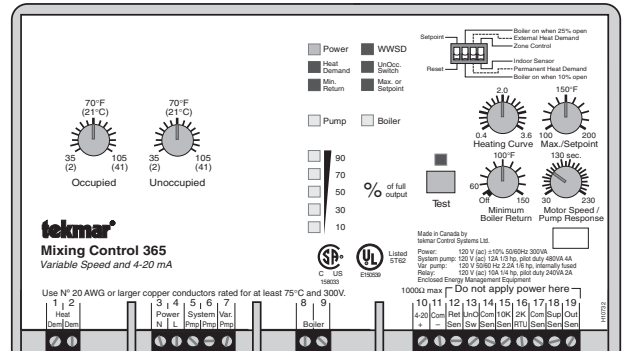

The installer must ensure that this control and its wiring are isolated and/or shielded from strong sources of electromagnetic noise. Conversely, this Class B digital apparatus complies with Part 15 of the FCC Rules and meets all requirements of the Canadian Interference-Causing Equipment Regulations. However, if this control does cause harmful interference to radio or television reception, which is determined by turning the control off and on, the user is encouraged to try to correct the interference by reorienting or relocating the receiving antenna, relocating the receiver with respect to this control, and/or connecting the control to a different circuit from that to which the receiver is connected.

Cet appareil numérique de la classe B respecte toutes les exigences du Règlement sur le matériel brouilleur du Canada.

Caution The nonmetallic enclosure does not provide grounding between conduit connections. Use grounding type bushings and jumper wires.

Attention Un boîtier nonmétallique n'assure pas la continuité électrique des conduits. Utiliser des manchons ou des fils de accord spécialement conçus pour la mise à la terre.

Limited Warranty and Product Return Procedure

Limited Warranty The liability of tekmar Control Systems Ltd. and tekmar Control Systems, Inc. ("tekmar") under this warranty is limited. The purchaser, by taking receipt of the tekmar product ("product"), acknowledges receipt of the terms of the warranty and acknowledges that it has read and understands same.

tekmar warrants each tekmar product against defects in workmanship and materials, if the product is installed and used in compliance with tekmar's instructions. The warranty period is for a period of twenty-four (24) months from the production date if the product is not installed during that period, or twelve (12) months from the documented date of installation if installed within twenty-four (24) months from the production date.

The liability of tekmar under this warranty shall be limited to, at tekmar's sole discretion: the cost of parts and labor provided by tekmar to repair defects in materials and/or workmanship of the defective product; or to the exchange of the defective product for a replacement product; or to the granting of credit limited to the original cost of the defective product, and such repair, exchange or credit shall be the sole remedy available from tekmar, and, without limiting the foregoing in any way, tekmar is not responsible, in contract, tort or strict product liability, for any other losses, costs, expenses, inconveniences, or damages, whether direct, indirect, special, secondary, incidental or consequential, arising from ownership or use of the product, or from defects in workmanship or materials, including any liability for fundamental breach of contract.

This warranty applies only to those products returned to tekmar during the warranty period. This warranty does not cover the cost of the parts or labor to remove or transport the defective product, or to reinstall the repaired or

replacement product. Returned products that are not defective are not covered by this warranty.

This warranty does not apply if the product has been damaged by negligence by persons other than tekmar, accident, fire, Act of God, abuse or misuse; or has been damaged by modifications, alterations or attachments made subsequent to purchase which have not been authorized by tekmar; or if the product was not installed in compliance with tekmar's instructions and the local codes and ordinances; or if due to defective installation of the product; or if the product was not used in compliance with tekmar's instructions.

This warranty is in lieu of all other warranties, express or implied, which the Governing Law (being the law of British Columbia) allows parties to contractually exclude, including, without limitation, warranties of merchantability, fitness for a particular purpose, durability or description of the product, its non-infringement of any relevant patents or trademarks, and its compliance with or non-violation of any applicable environmental, health or safety legislation; the term of any other warranty not hereby contractually excluded is limited such that it shall not extend beyond twenty-four (24) months from the production date, to the extent that such limitation is allowed by the Governing Law.

Product Return Procedure Products that are believed to have defects in workmanship or materials must be returned, together with a written description of the defect, to the tekmar representative for that territory. If the address of the representative is not known, please request it from tekmar at the telephone number listed below.

tekmar
Control Systems

tekmar Control Systems Ltd., Canada
tekmar Control Systems, Inc., U.S.A.
Head Office: 4611 - 23rd Street
Vernon, B.C. Canada V1T 4K7
Tel. (250) 545-7749 Fax. (250) 545-0650
Web Site: www.tekmarcontrols.com